



RAZER NOMMO CHROMA

MASTER GUIDE

The **Razer Nommo Chroma** is designed for gamers who want to flood their rooms with the sounds of their favorite games, music and movies. With Kevlar[®]-coated 77mm drivers, a wide sound field with high positional accuracy, dedicated rear-facing firing bass ports and bass control with automatic gain control technology, you have the ultimate in power and versatility.

CONTENTS

1. PACKAGE CONTENTS / SYSTEM REQUIREMENTS	3
2. REGISTRATION / TECHNICAL SUPPORT	4
3. TECHNICAL SPECIFICATIONS	5
4. DEVICE LAYOUT	6
5. SETTING UP YOUR RAZER NOMMO CHROMA	7
6. INSTALLING RAZER SYNAPSE FOR YOUR RAZER NOMMO CHROMA.....	10
7. USING YOUR RAZER NOMMO CHROMA	11
8. CONFIGURING YOUR RAZER NOMMO CHROMA.....	14
9. SAFETY AND MAINTENANCE	24
10. LEGALESE	26

1. PACKAGE CONTENTS / SYSTEM REQUIREMENTS

PACKAGE CONTENTS

- Razer Nommo Chroma 2.0 gaming speakers
- 3.5mm audio cable
- Power adapter with interchangeable plugs*
- Important Product Information Guide

**May vary for specific regions*

SYSTEM REQUIREMENTS

PRODUCT REQUIREMENTS

- PC or Mac with a free USB port

RAZER SYNAPSE 3 REQUIREMENTS

- Windows® 7 (or higher)
- Internet connection
- 500 MB of free hard disk space

RAZER SYNAPSE REQUIREMENTS

- OS X 10.9® (or higher)
- Internet connection
- 100 MB of free hard disk space

2. REGISTRATION / TECHNICAL SUPPORT

REGISTRATION

Register your product online at razer-id.razerzone.com/warranty to get real-time information on your product's warranty status.

If you haven't registered for a Razer ID yet, register now at razer-id.razerzone.com to get a wide range of Razer benefits.

Your product's serial number can be found here.

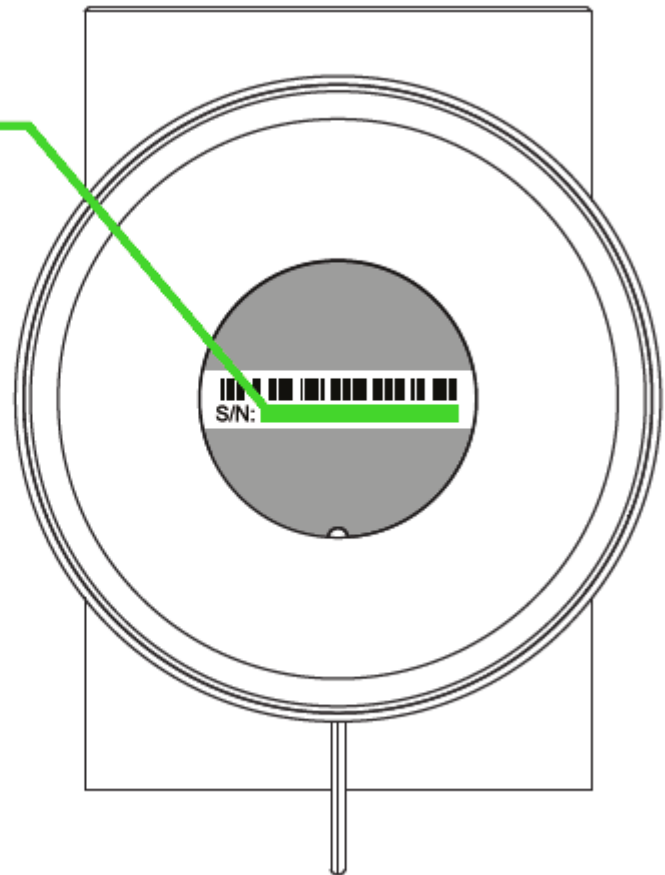

TECHNICAL SUPPORT

- 1 year limited manufacturer's warranty.
- Free online technical support at support.razerzone.com.

3. TECHNICAL SPECIFICATIONS

TECHNICAL SPECIFICATIONS

- 2 x 77mm full range drivers (1 x per speaker)
- Frequency response: 50-20,000khz
- USB audio
- 1 x 3.5mm aux input jack
- 1 x 3.5mm headphone jack
- Bass and Volume Control
- Chroma enabled

4. DEVICE LAYOUT

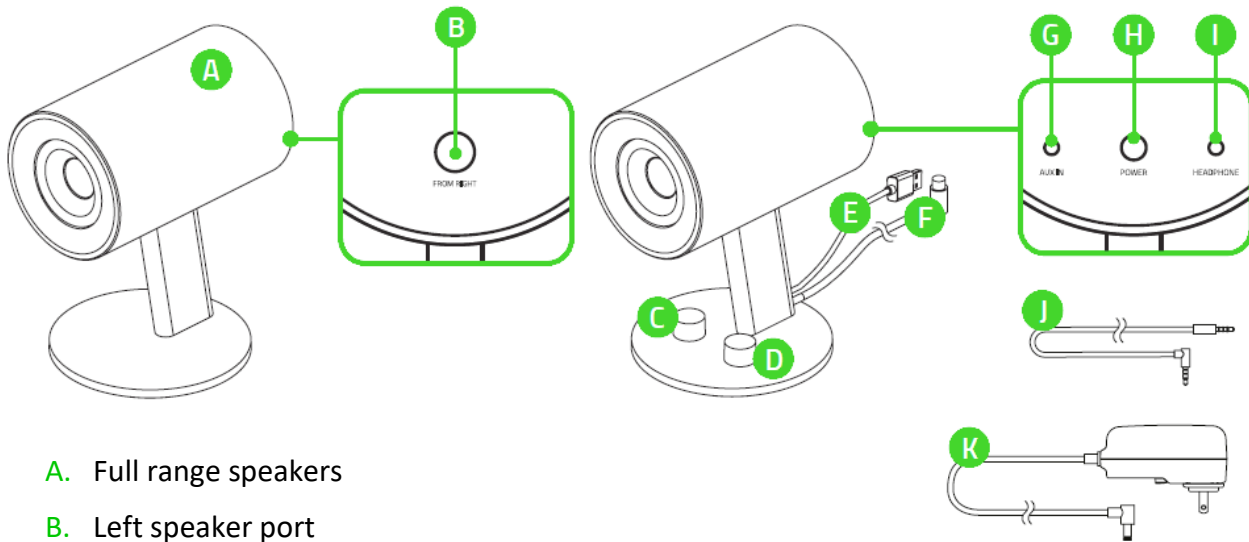

- A. Full range speakers
- B. Left speaker port
- C. Bass control
- D. Power button / volume control
- E. USB connector
- F. Left speaker cable
- G. Aux input port
- H. DC power port
- I. Headphone output port
- J. 3.5 mm audio cable
- K. Power adapter
- L. Regional plugs

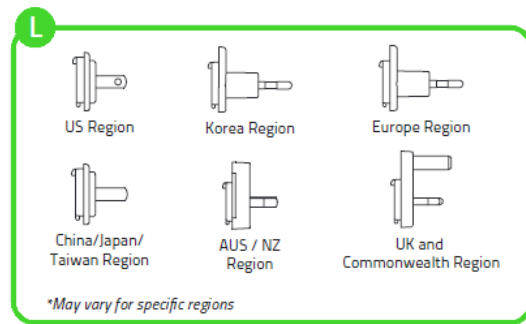

5. SETTING UP YOUR RAZER NOMMO CHROMA

1. Attach the regional plug to the power adapter.

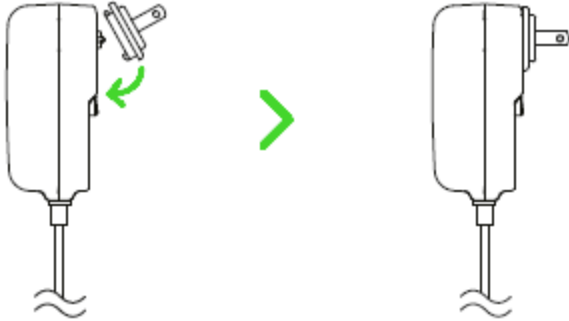

2. Plug the power adapter from your speakers to an appropriate power source.

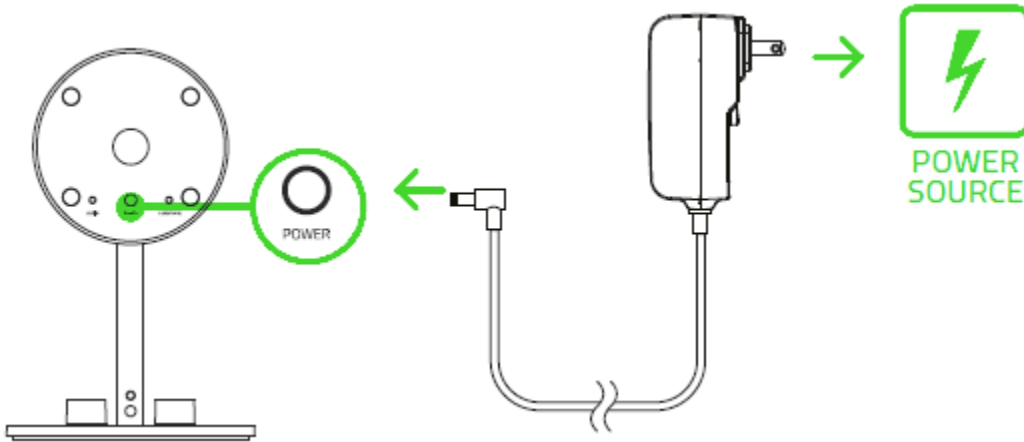

3. Plug the left speaker cable to the left speaker port.

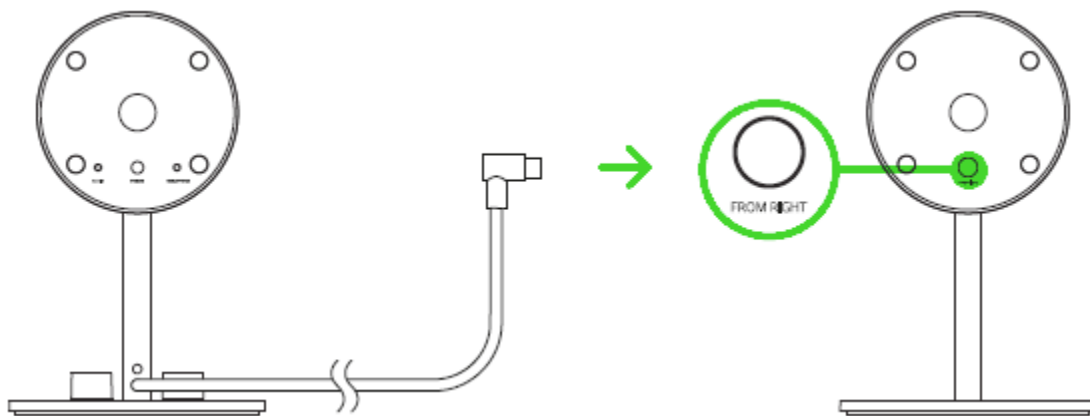

4. Connect your Razer Nommo Chroma to the USB port of your computer.

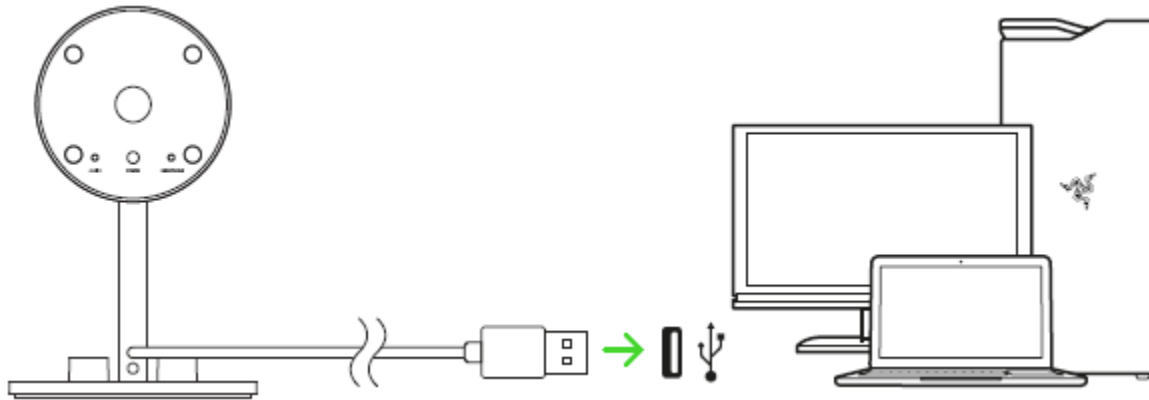

SETTING THE DEFAULT PLAYBACK DEVICE

If you are using the Razer Nommo Chroma for the first time, you may be required to set up the device as your system's default playback device.

FOR WINDOWS USERS

Step 1: Open your **Sound** settings from **Control Panel > Hardware and Sound > Manage audio devices**. You can also right-click your sound icon on the system tray and select **Playback devices**.

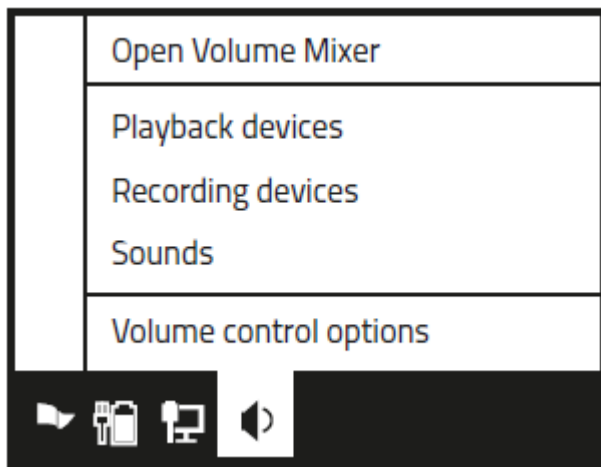

Step 2: In the **Playback** tab, select Razer Nommo Chroma from the list and click the **Set Default** button.

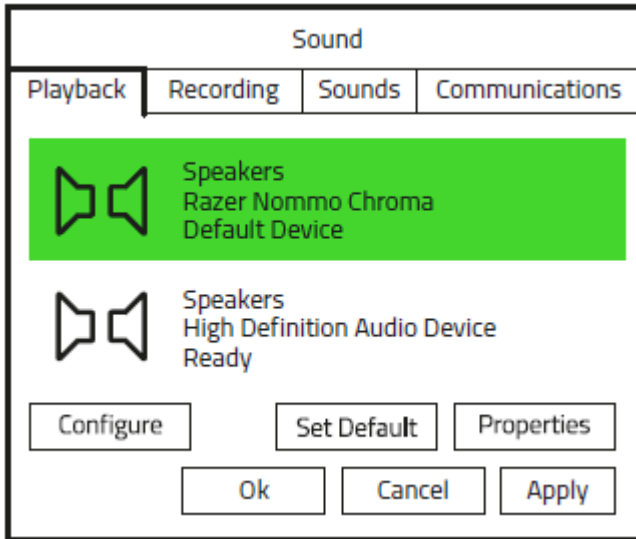

FOR MAC USERS

Step 1: Open your **Sound** settings from **System Preferences > Sound**.

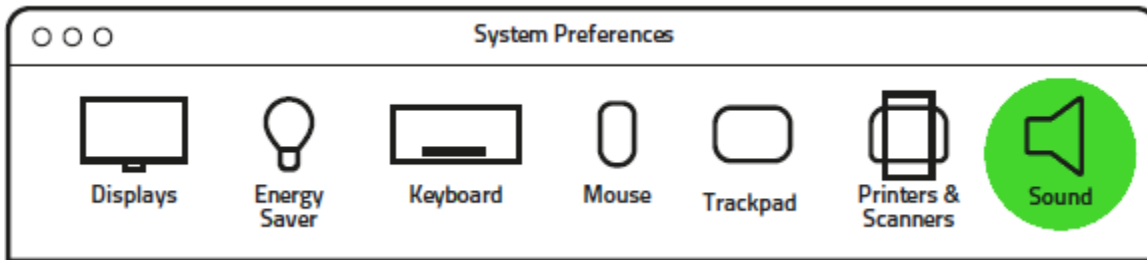

Step 2: In the **Output** tab, select Razer Nommo Chroma from the list.



Name	Type
Headphones	Built-in Output
Line Out	Built-in Line Output
Razer Nommo Chroma	USB

6. INSTALLING RAZER SYNAPSE FOR YOUR RAZER NOMMO CHROMA

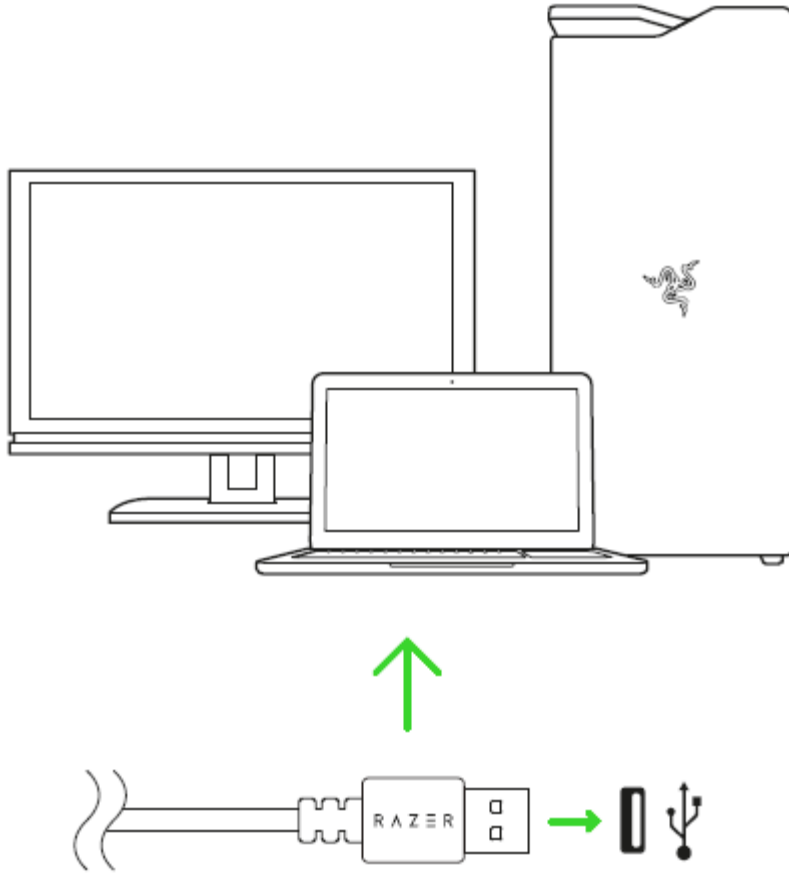

Step 1: Make sure your Razer device is connected to the USB port of your computer.

Step 2: Install Razer Synapse 3 when prompted* or download the installer from razerzone.com/synapse.

Step 3: Create your Razer ID or log into Razer Synapse with an existing account.

**Applicable for Windows 8 or later.*

7. USING YOUR RAZER NOMMO CHROMA

POWERING ON / OFF

To power on the speakers, simply press the volume control until you hear a click and press the volume control again to power off the speakers.

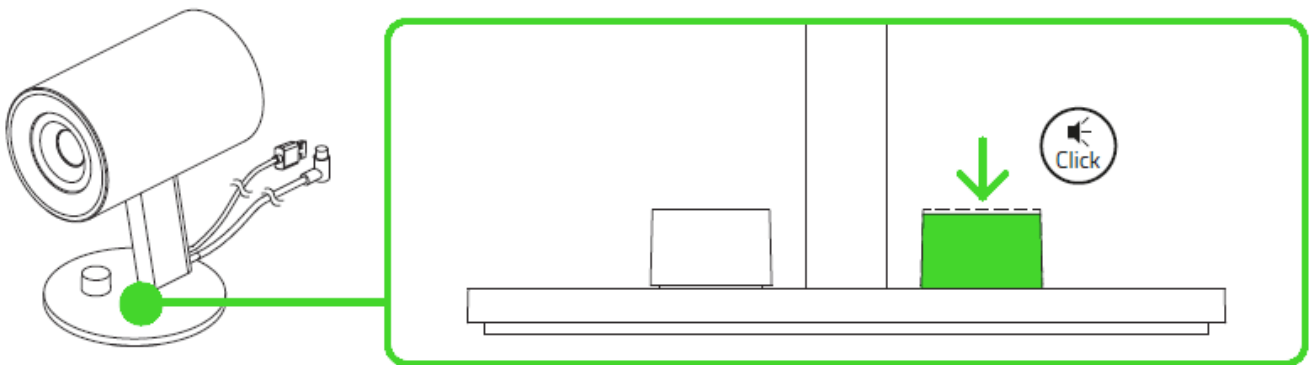

USING THE VOLUME CONTROL

While powered on, rotate the volume control to increase or decrease the volume. This function also works on the headphone that is connected to your Razer Nommo Chroma.



USING THE BASS CONTROL

Rotate the bass control clockwise to increase or counter-clockwise to decrease the bass levels. This function also works on the headphone that is connected to your Razer Nommo Chroma.



USING THE AUX INPUT PORT

Plug the 3.5mm cable from the aux input port of your Razer Nommo Chroma to your audio device. If the audio input port and aux input port are in use, Razer Nommo Chroma will combine both sounds.

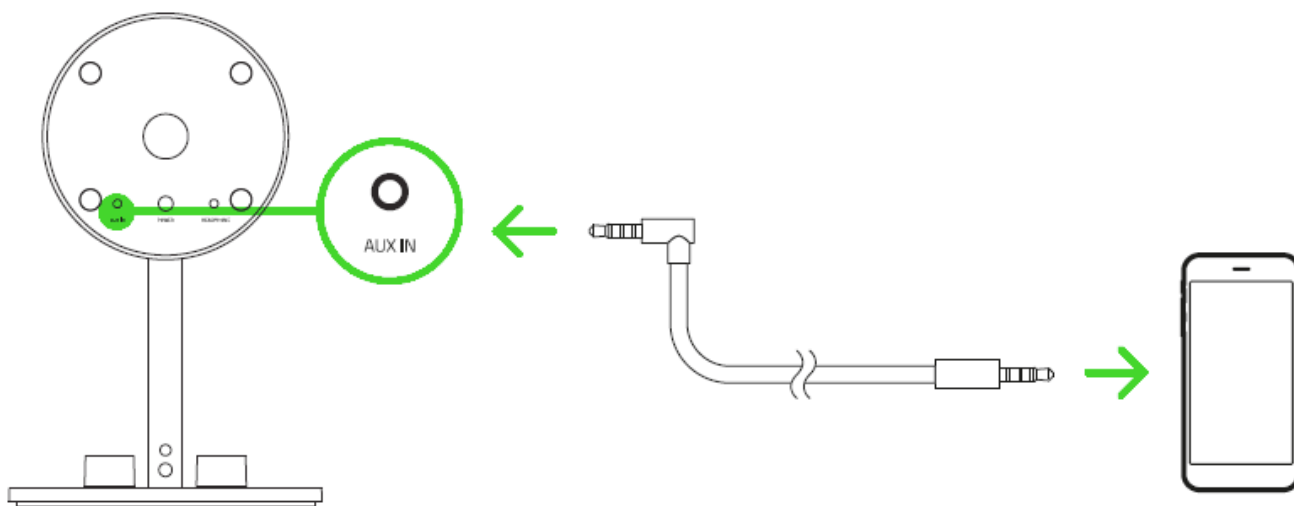

USING THE HEADPHONE OUTPUT PORT

While powered on, connect your headphone to the headphone output port of your Razer Nommo Chroma.

Note: The sound output will automatically switch from the speakers to the headphones.

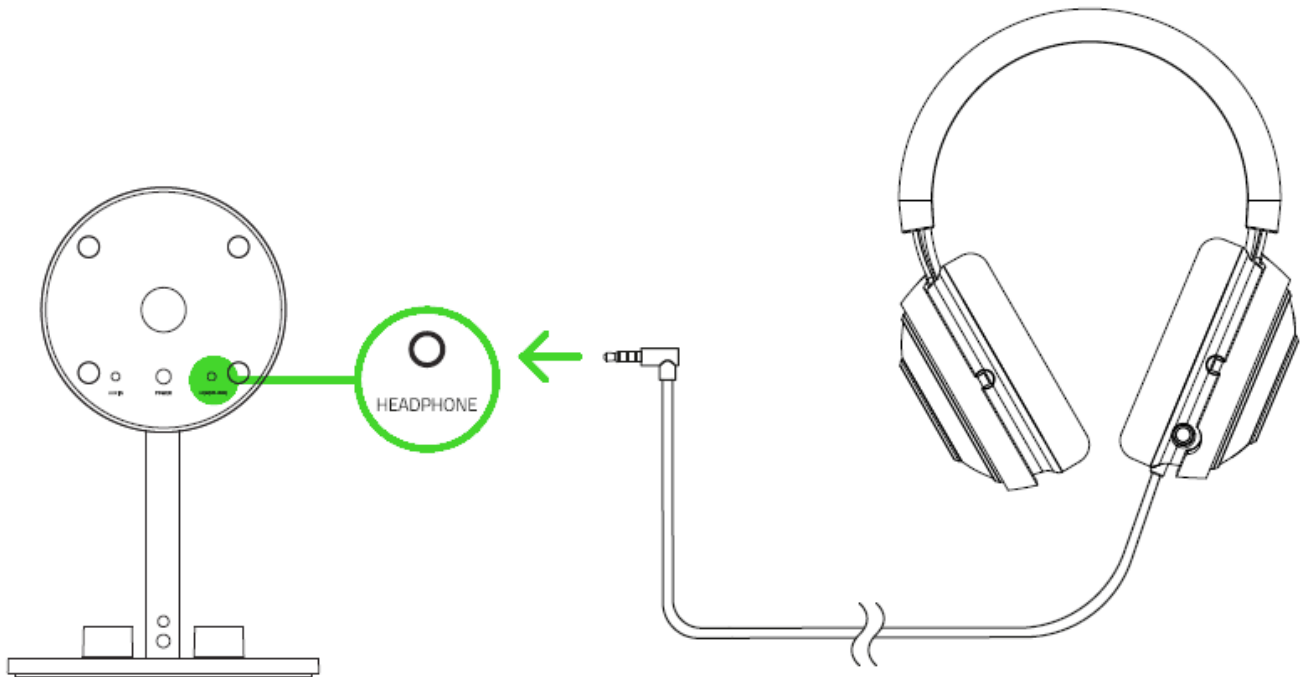

8. CONFIGURING YOUR RAZER NOMMO CHROMA

Disclaimer: The features listed here require you to log in to Razer Synapse. These features are also subject to change based on the current software version and your Operating System.

SYNAPSE TAB

The Synapse tab is your default tab when you first launch Razer Synapse 3. This tab allows you to navigate the Dashboard subtab.

Dashboard

The Dashboard subtab is an overview of your Razer Synapse 3 where you can access all your Razer devices, modules, and online services.

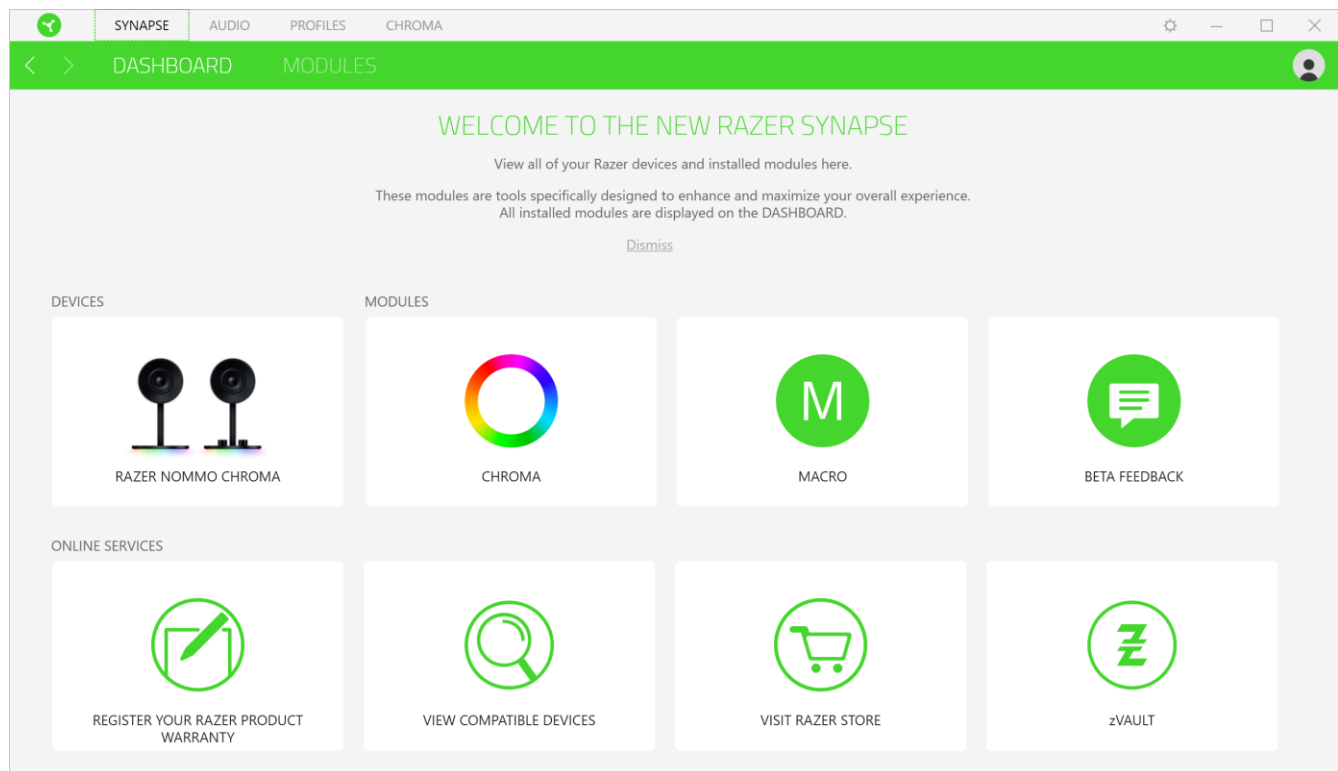

AUDIO TAB

The Audio tab is the main tab for your Razer Nommo Chroma. From here, you can customize your device's settings to unleash its full potential. Changes made under this tab are automatically saved to your system and cloud storage.

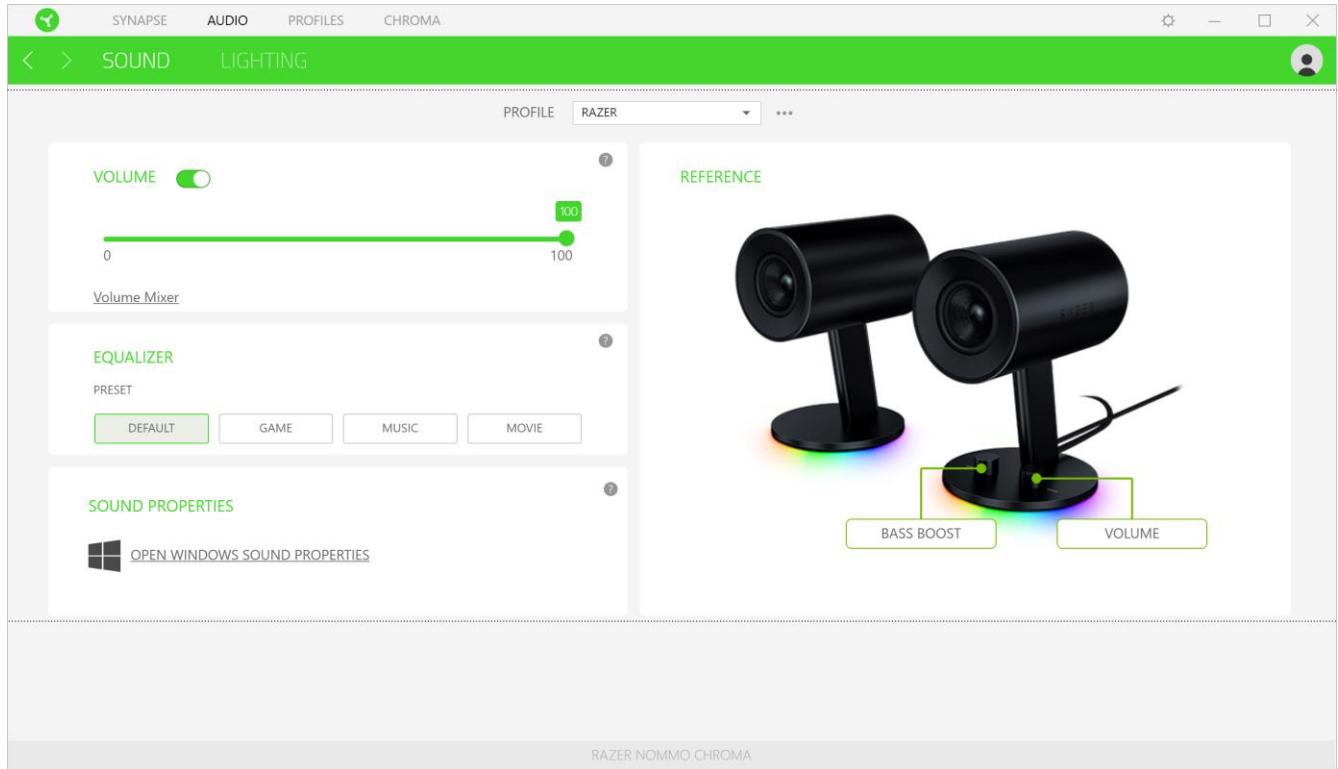

Sound

The Sound subtab is for modifying your device's volume, equalizer presets, and sound properties.

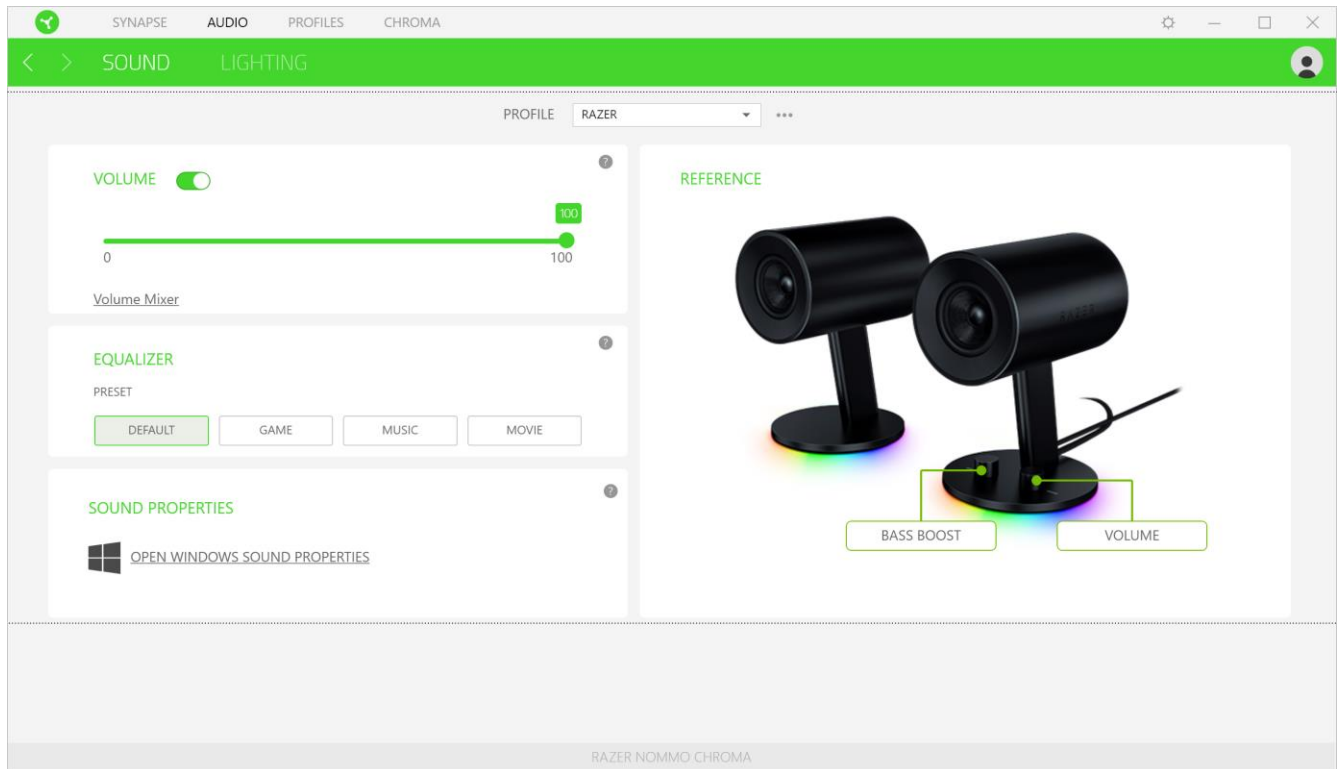

Profile

Profile is a data storage for keeping all your Razer peripheral's settings. By default, the profile name is based on your system's name. To add, rename, duplicate, or delete a profile, simply press the Miscellaneous button (●●●).

Volume

This option enables you to mute, increase, or decrease the audio output settings.

Equalizer

The equalizer setting allow you to change the frequency response of the speakers, changing the bass, midrange, and treble to better suit your listening preference.

Sound Properties

Clicking the link will launch the Windows sound properties window.

Reference

Reference is a visual representation of your Razer Nommo Chroma highlighting key elements on the product.

Lighting

The Lighting subtab enables you to modify your Razer device's light settings.

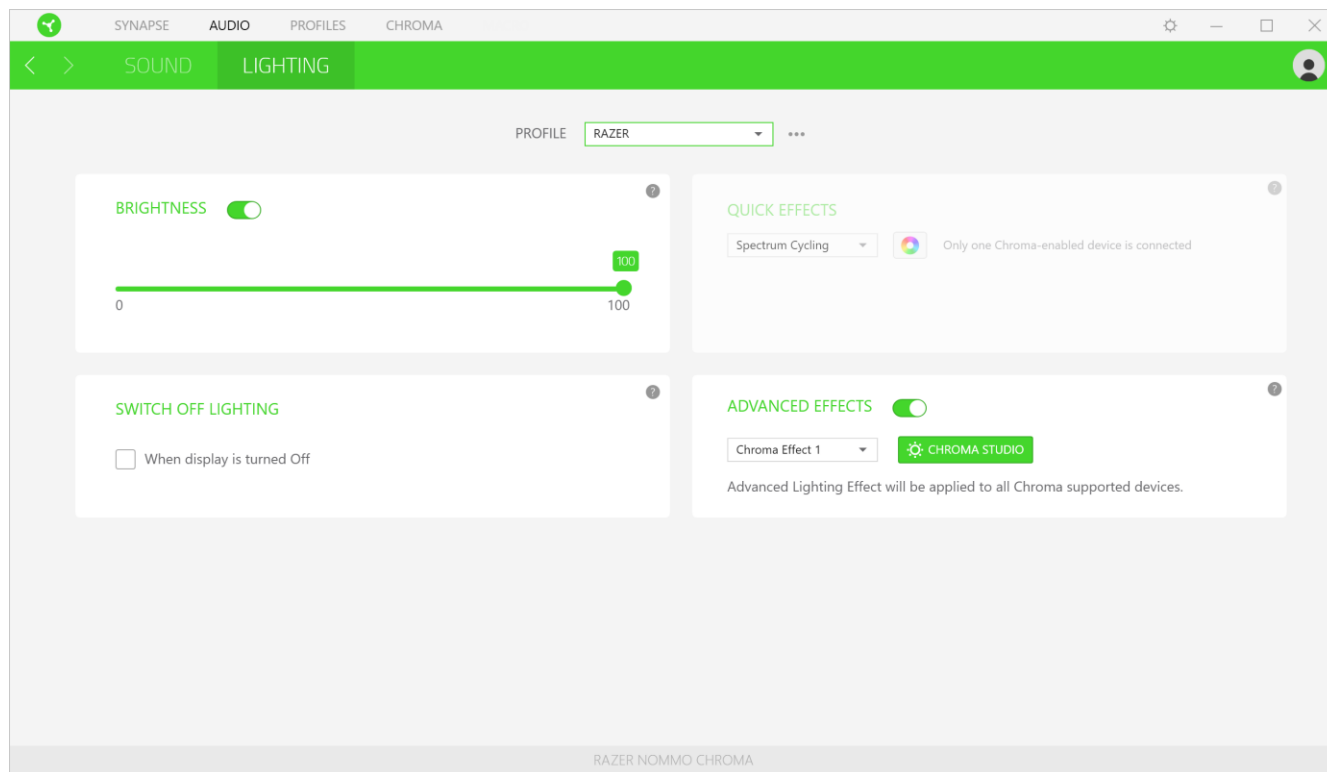

Brightness

You can turn off your Razer device's lighting by toggling the Brightness option or increase/decrease the luminance using the slider.





Switch Off Lighting

This is a power saving tool which allows you to disable your device's lighting in response to your system's display turning off and/or automatically power down when your Razer Nommo Chroma has been idle for a set amount of time.

Quick Effects

A number of quick effects can be selected and applied to your mouse's lighting, as listed here:

Name	Description	How to set up
------	-------------	---------------

	Breathing	The lighting fades in and out of the selected color(s)	Select up to 2 colors or randomize
	Spectrum Cycling	The LEDs will cycle between 16.8 million colors indefinitely	No further customization required
	Static	The LEDs will remain lit in the selected color	Select a color
	Wave	The lighting will scroll in the direction selected with a default spectrum of colors	Select either left-to-right or right-to-left wave direction

If you have other supported Razer Chroma-enabled devices, you can synchronize their quick effects with your Razer device by clicking the Chroma Sync button ().

Advanced Effects

The Advanced Effects option allows you to choose a Chroma Effect you want to use on your Razer Chroma-enabled peripheral. To start making your own Chroma Effect, simply press the Chroma Studio button (). [Click here to learn more about the Chroma Studio](#)

PROFILES TAB

The Profiles tab is a convenient way of managing all your profiles and linking them to your games and applications.

Devices

View which Razer device is using a specific profile using the Devices subtab. To create a new profile within the selected device, simply click the add button (+). To rename, duplicate, or delete a profile, simply press the Miscellaneous button (●●●). Each profile can be set to automatically activate when you run an application using the Link Games option.

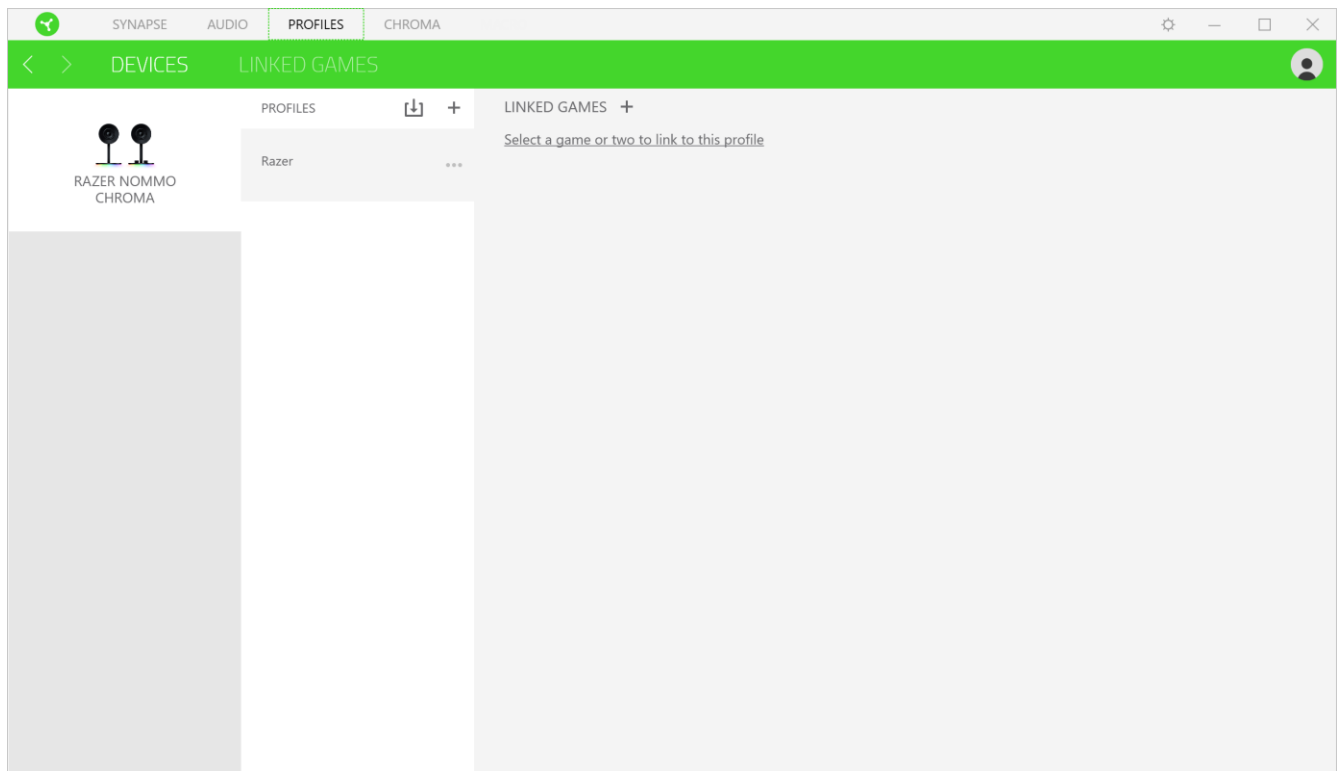

Linked Games

The Linked Games subtab gives you the flexibility to add games, view peripherals that are linked to games, or search for added games. You can also sort games based on alphabetical order, last played, or most played. Added games will still be listed here even if it is not linked to a Razer device.

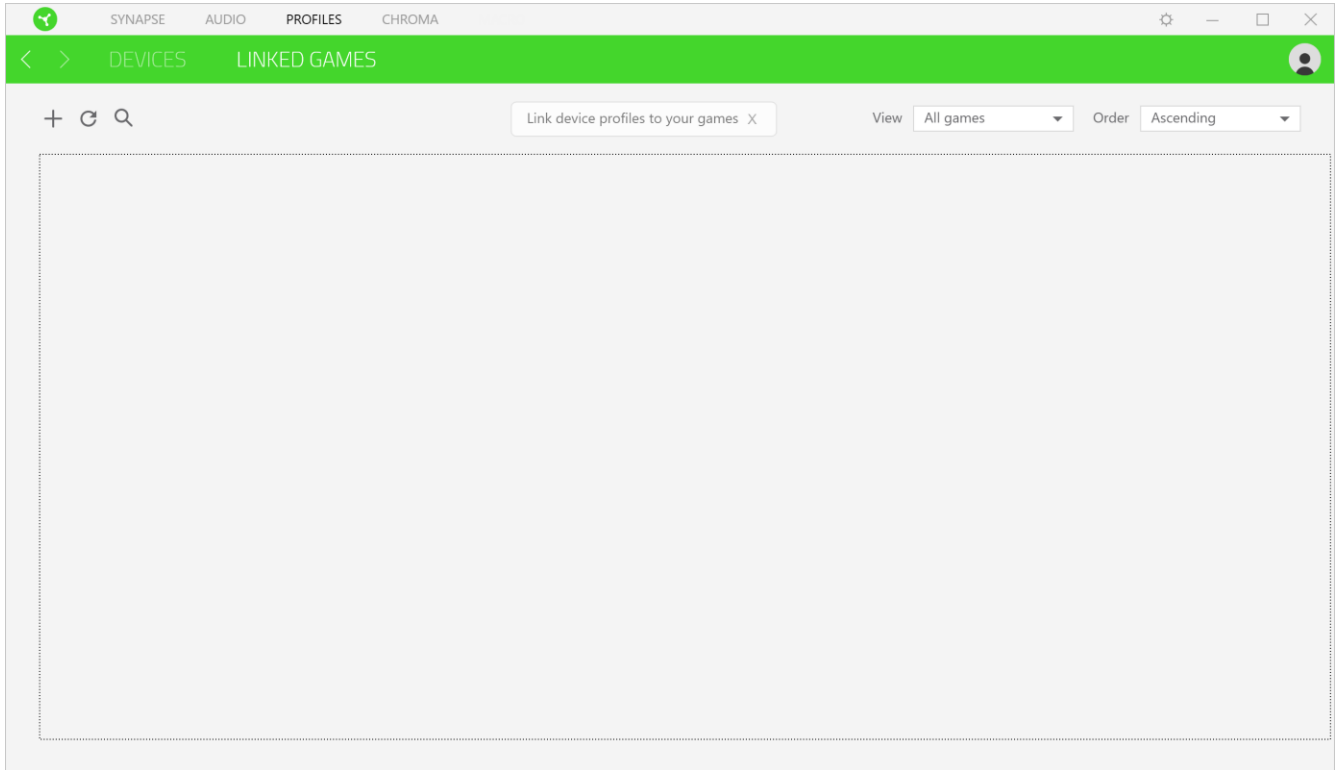

CHROMA TAB

The Chroma tab enables you to either create advanced lighting effects through the Studio subtab or enable/disable third party integrated apps to all Razer Chroma-enabled devices for a truly immersive lighting and gaming experience.

Studio

The Studio subtab enables you to create and edit your own Chroma Effects which you can apply to all supported Razer Chroma-enabled devices. This tab can also be accessed under the Dashboard's Chroma module.

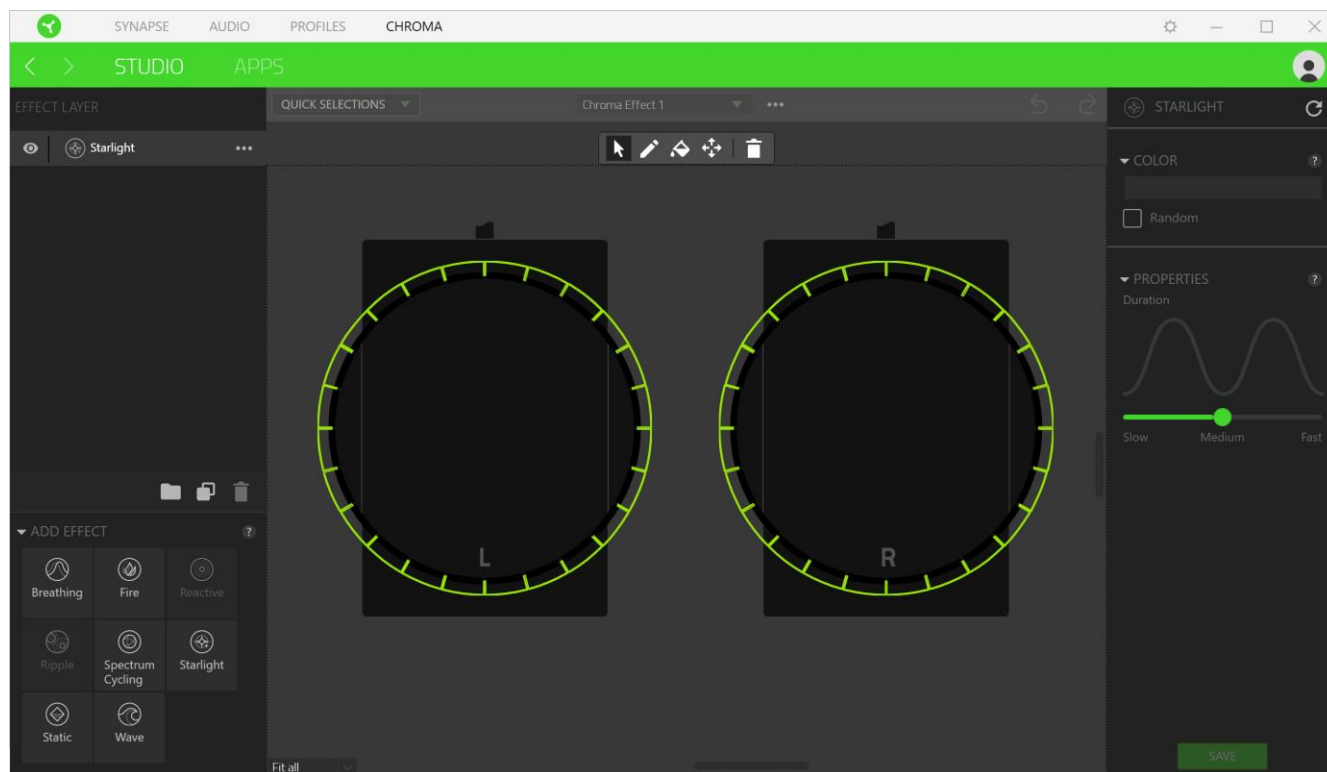

To add, rename, duplicate, or delete a Chroma Effect, simply click the Miscellaneous button (**⋮**). To revert the selected layer to its original setting, click the Reset button (**↺**). And to apply and save a modified layer, click the Save button (**SAVE**).



Quick Selections

The Quick Selections menu are a preset of lighting regions which you can use to easily customize your Razer device. Alternatively, you can individually select an LED by clicking on the area or select multiple LEDs by using click and drag.

Effect Layer

Lighting effects are arranged in layers wherein the topmost layer takes priority. . You can group multiple lighting effects by clicking the Add Group button () and dragging the layers you want to group to the newly added folder, duplicate a layer by clicking the Copy button (), or delete a layer by clicking the Trash button (). Some layers may have overlapping effects so you may need to arrange layers in a specific order.

Add Effect

All supported quick effects are listed under the Add Effect option which you can click to insert onto the Effect Layer. Quick Effects can be edited on the Chroma Studio by allowing you to change its preset color, properties, and playback options.

Apps

The Apps subtab is where you can enable or disable third party integrated apps for your Razer Chroma-enabled peripherals. The Apps tab can also direct you to the Chroma Workshop where you can download these third-party apps.

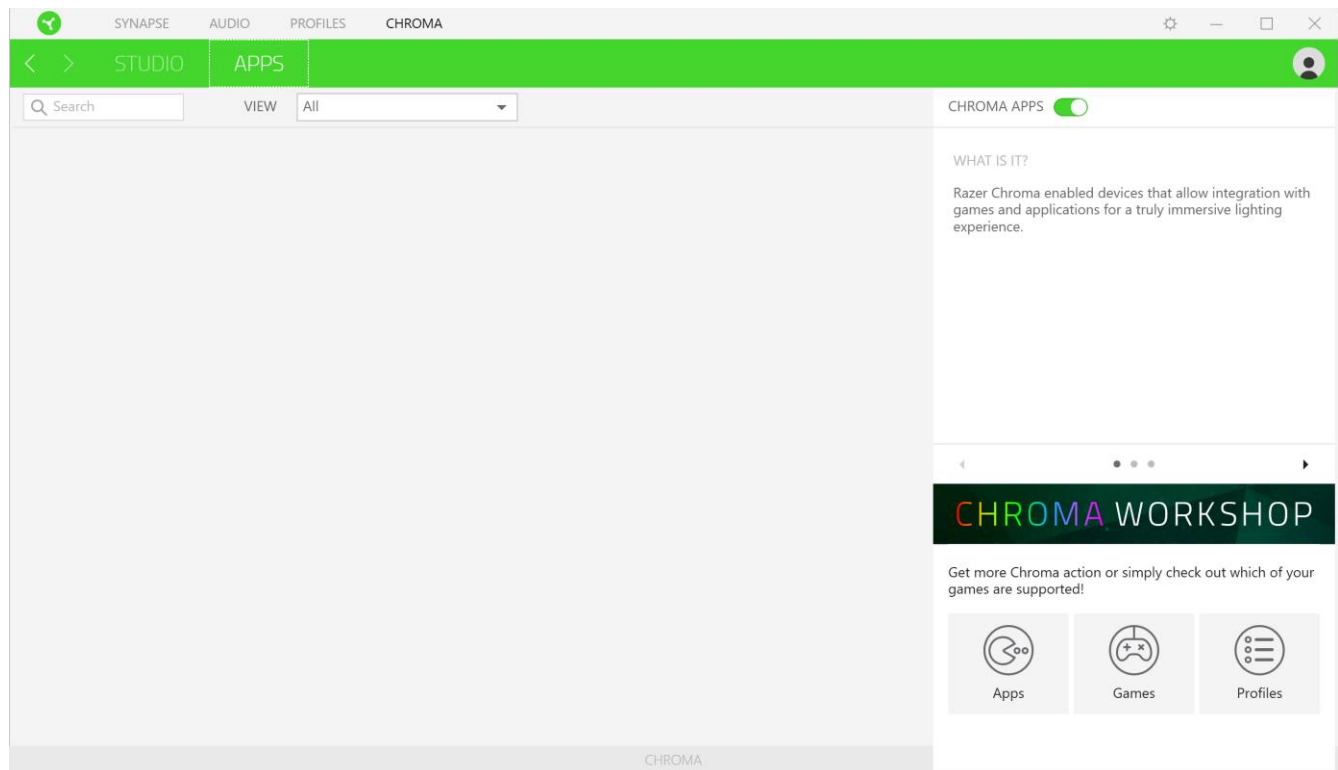

SETTINGS WINDOW

The Settings window, accessible by clicking the () button on Razer Synapse 3, enables you to configure the startup behavior, change language, view your Razer device's master guide, or perform factory reset on any connected Razer device.

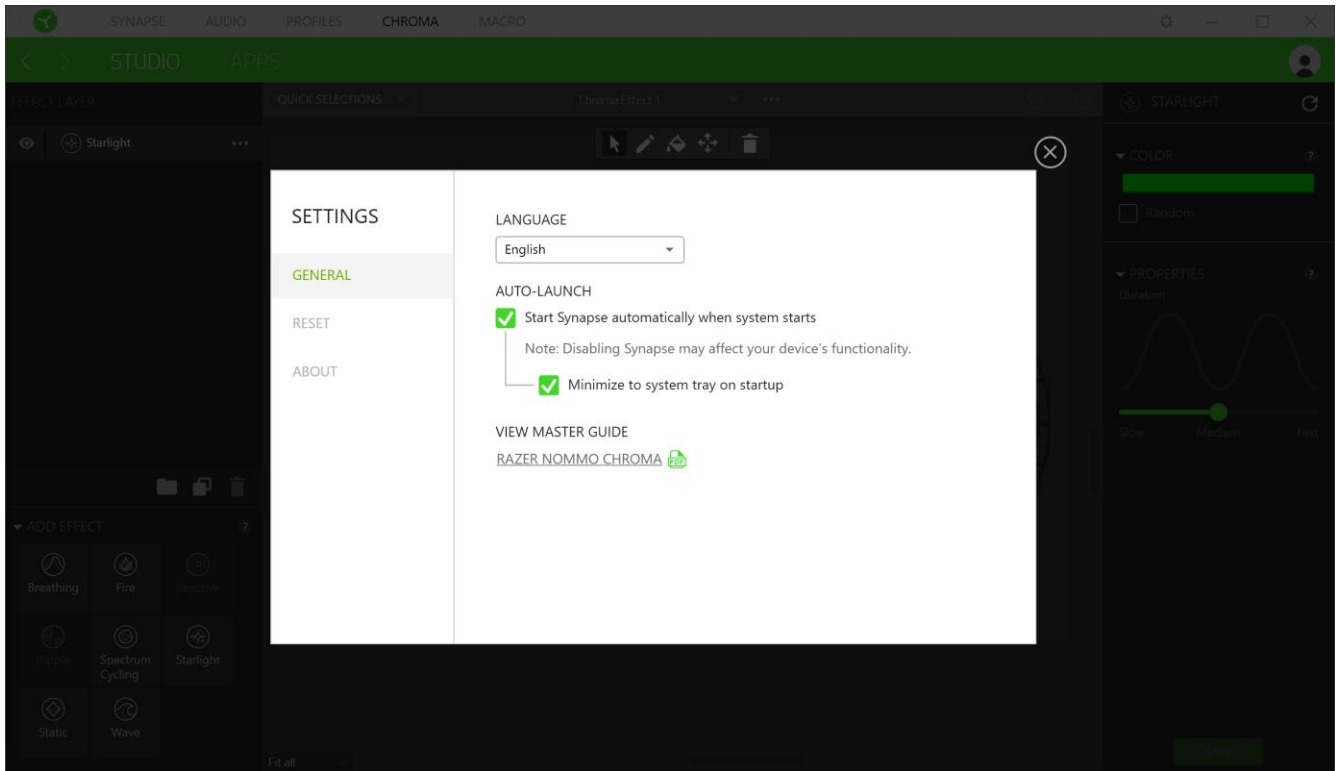

General tab

The default tab of the Settings window, The General tab enables you to change the software's display language and start-up behavior, or view the master guide of all connected Razer devices.

Reset tab

The Reset tab allows you to perform a factory reset on all connected Razer devices with on-board memory. All profiles stored on the selected device's on-board memory will be erased.

Note: Performing a factory reset on devices without on-board memory will only create a new profile for your device on Razer Synapse 3 using the default settings.

About tab

The About tab displays brief software information, its copyright statement, and also provides relevant links for its terms of use. You may also use this tab to check for software updates, or as a quick access to Razer's social communities.

9. SAFETY AND MAINTENANCE

SAFETY GUIDELINES

In order to achieve maximum safety while using your Razer Nommo Chroma, we suggest that you adopt the following guidelines:

Should you have trouble operating the device properly and troubleshooting does not work, unplug the device and contact the Razer hotline or go to [razersupport.com](https://www.razer.com/support) for support.

Do not take apart the device (doing so will void your warranty) and do not attempt to operate it under abnormal current loads.

Keep the device away from liquid, humidity or moisture. Operate the device only within the specific temperature range of 0°C (32°F) to 40°C (104°F). Should the temperature exceed this range, unplug and/or switch off the device in order to let the temperature stabilize to an optimal level.

COMFORT

Research has shown that long periods of repetitive motion, improper positioning of your computer peripherals, incorrect body position, and poor habits may be associated with physical discomfort and injury to nerves, tendons, and muscles. Below are some guidelines to avoid injury and ensure optimum comfort while using your Razer Nommo Chroma.

- Position your keyboard and monitor directly in front of you with your mouse next to it. Place your elbows next to your side, not too far away and your keyboard within easy reach.
- Adjust the height of your chair and table so that the keyboard and mouse are at or below elbow-height.
- Keep your feet well supported, posture straight and your shoulders relaxed.
- During gameplay, relax your wrist and keep it straight. If you do the same tasks with your hands repeatedly, try not to bend, extend or twist your hands for long periods.
- Do not rest your wrists on hard surfaces for long periods. Use a wrist rest to support your wrist while gaming.
- Customize the keys on your keyboard to suit your style of gaming in order to minimize repetitive or awkward motions while gaming.
- Do not sit in the same position all day. Get up, step away from your desk and do exercises to stretch your arms, shoulders, neck and legs.

If you should experience any physical discomfort while using your mouse, such as pain, numbness, or tingling in your hands, wrists, elbows, shoulders, neck or back, please consult a qualified medical doctor immediately.

MAINTENANCE AND USE

The Razer Nommo Chroma requires minimum maintenance to keep it in optimum condition. Once a month we recommend you unplug the device from the computer and clean it using a soft cloth or cotton swab with a bit of warm water to prevent dirt buildup. Do not use soap or harsh cleaning agents.

To get the ultimate experience in movement and control, we highly recommend a premium mouse mat from Razer. Some surfaces will cause undue wear on the feet requiring constant care and eventual replacement.

Do note that the sensor of the Razer Nommo Chroma is 'tuned' or optimized especially for the Razer mouse mats. This means that the sensor has been tested extensively to confirm that the Razer Nommo Chroma reads and tracks best on Razer mouse mats.

10. LEGALESE

COPYRIGHT AND INTELLECTUAL PROPERTY INFORMATION

©2018 Razer Inc. All rights reserved. Razer, the triple-headed snake logo, Razer logo, "For Gamers. By Gamers.", and "Powered by Razer Chroma" logo are trademarks or registered trademarks of Razer Inc. and/or affiliated companies in the United States or other countries. All other trademarks and trade names are the property of their respective owners and other company and product names mentioned herein may be trademarks of their respective companies.

Windows and the Windows logo are trademarks or registered trademarks of the Microsoft group of companies.

Mac OS, Mac and the Mac logo are trademarks or registered trademarks of Apple.

OS X, Mac and the Mac logo are trademarks or registered trademarks of Apple.

Android™ and Google Play™ are trademarks of Google Inc.

The Bluetooth® word mark and logos are registered trademarks owned by Bluetooth SIG, Inc., and any use of such marks by Razer is under license.

Apple, the Apple logo, iPod, iPhone and iPad are trademarks of Apple Inc., registered in the U.S. and other countries. iOS is a trademark or registered trademark of Cisco in the U.S. and other countries and is used under license. App Store is a service mark of Apple Inc. "Made for iPod," "Made for iPhone," and "Made for iPad" mean that an electronic accessory has been designed to connect specifically to iPod, iPhone, or iPad, respectively, and has been certified by the developer to meet Apple performance standards. Apple is not responsible for the operation of this device or its compliance with safety and regulatory standards.

© 2016 Blizzard Entertainment, Inc. All rights reserved. Overwatch™ is a trademark and Blizzard Entertainment is a trademark and/or registered trademark of Blizzard Entertainment, Inc., in the U.S. and/or other countries.

Manufactured under license from Dolby Laboratories. Dolby, Dolby Digital Plus Home Theater Edition and the double-D symbol are trademarks of Dolby Laboratories.

Thunderbolt and the Thunderbolt logo are trademarks of Intel Corporation in the U.S. and/or other countries.

The terms HDMI and HDMI High-Definition Multimedia Interface, and the HDMI logo are trademarks or registered trademarks of HDMI Licensing LLC in the United States and other countries.

Razer Inc. (“Razer”) may have copyright, trademarks, trade secrets, patents, patent applications, or other intellectual property rights (whether registered or unregistered) concerning the product in this guide. Furnishing of this guide does not give you a license to any such copyright, trademark, patent or other intellectual property right. The Razer Nommo Chroma (the “Product”) may differ from pictures whether on packaging or otherwise. Razer assumes no responsibility for such differences or for any errors that may appear. Information contained herein is subject to change without notice.

LIMITED PRODUCT WARRANTY

For the latest and current terms of the Limited Product Warranty, please visit [razerzone.com/warranty](https://www.razerzone.com/warranty).

LIMITATION OF LIABILITY

Razer shall in no event be liable for any lost profits, loss of information or data, special, incidental, indirect, punitive or consequential or incidental damages, arising in any way out of distribution of, sale of, resale of, use of, or inability to use the Product. In no event shall Razer’s liability exceed the retail purchase price of the Product.

COSTS OF PROCUREMENT

For the avoidance of doubt, in no event will Razer be liable for any costs of procurement unless it has been advised of the possibility of such damages, and in no case shall Razer be liable for any costs of procurement liability exceeding the retail purchase price of the Product.

GENERAL

These terms shall be governed by and construed under the laws of the jurisdiction in which the Product was purchased. If any term herein is held to be invalid or unenforceable, then such term (in so far as it is invalid or unenforceable) shall be given no effect and deemed to be excluded without invalidating any of the remaining terms. Razer reserves the right to amend any term at any time without notice.