

# **SAMSUNG**

## **Galaxy Tab Active Pro**

**User manual**



# Table of contents

---

<b>Features</b>	<b>1</b>
S Pen	1
Camera	1
Bixby	1
Mobile continuity	1
Night mode	1
Expandable storage	1
Security	1
<b>Getting started</b>	<b>2</b>
Front view	3
Back view	4
Assemble your device	5
Install cards and the battery	6
Charge the battery	9
Install the bumper	10
Start using your device	11
Use the setup wizard	11
Lock or unlock your device	12

Side key settings	13
Active key settings	13
Accounts	14
Transfer data from an old device	15
Navigation	16
Customize your home screen	21
S Pen	27
Bixby	33
Digital wellbeing	34
Flexible security	35
Mobile continuity	37
Multi window	38
Enter text	40
<b>Apps</b>	<b>44</b>
Using apps	45
Uninstall or disable apps	45
Search for apps	45
Sort apps	45
Create and use folders	46

App settings	46
Samsung apps	48
Galaxy Essentials	48
Bixby	48
Galaxy Store	48
PENUP	48
Samsung Flow	49
Samsung Notes	50
SmartThings	52
Calculator	53
Calendar	54
Camera	56
Clock	60
Contacts	65
Gallery	70
Internet	74
Messages	77
My Files	79
Phone	81

Google apps	86
Chrome	86
Drive	86
Duo	86
Gmail	86
Google	86
Maps	87
Photos	87
Play Movies & TV	87
Play Music	87
Play Store	87
YouTube	87
Microsoft apps	88
Outlook	88
Office Mobile	89
OneDrive	89
Additional apps	90
Spotify	90

<b>Settings</b>	<b>91</b>
Access Settings	92
Search for Settings	92
Connections	92
Wi-Fi	92
Bluetooth	94
Tablet visibility	95
Airplane mode	96
Data usage	96
Mobile hotspot	96
Tethering	98
Nearby device scanning	98
Connect to a printer	99
Virtual Private Networks	99
Private DNS	100
Ethernet	100
Sounds and vibration	100
Sound mode	100
Vibrations	101

Ringtone	101
Notification sounds	101
Volume	102
System sounds	102
Dolby Atmos	103
Equalizer	103
Headset audio options	103
Adapt sound	104
Separate app sound	104
Notifications	104
Manage notifications	104
Customize app notifications	105
Smart pop-up view	105
Display	105
Screen brightness	105
Night mode	106
Font size and style	106
Screen zoom	106
Screen timeout	106

Accidental touch protection	107
Touch sensitivity	107
Screen saver	107
Reduce animations	107
Double tap to wake	108
Smart stay	108
Device maintenance	108
Quick optimization	108
Battery	109
Storage	109
Memory	110
Security	110
Language and input	111
Date and time	113
Troubleshooting	114
Lock screen and security	117
Screen lock types	117
Google Play Protect	118
Find My Mobile	118



Security update	119
Samsung Pass	119
Install unknown apps	119
Secure Folder	120
Encrypt SD card	120
View passwords	120
Security update service	121
Device administration	121
Credential storage	121
Strong protection	121
Advanced security settings	122
Location	122
App permissions	123
Send diagnostic data	123
Accounts	124
Add an account	124
Account settings	124
Remove an account	124
Users	125

Samsung Cloud	125
Backup and restore	126
Google settings	126
Accessibility	127
Screen reader	127
Visibility enhancements	127
Hearing enhancements	128
Interaction and dexterity	129
Advanced settings	130
Installed services	131
Other settings	131
Help	131
Daily Board	131
About tablet	132
<b>Learn more</b>	<b>133</b>
Videos	133
Smart Simulator	133
Tips	133
Samsung Care	133

Talk to an agent	133
<b>Legal information</b>	<b>134</b>
Samsung Knox	134
Restricting children's access to your mobile device	135

# Features

---



## S Pen

The S Pen is designed for special functions with Samsung Galaxy devices. See [S Pen](#) on page 27.



## Camera

The camera on your device has several unique features. See [Camera](#) on page 56.



## Bixby

Bixby learns what you like to do and works with your favorite apps and services to help you get more done. See [Bixby](#) on page 33.



## Mobile continuity

Transition between your mobile devices and personal computers for messaging, phone calls, receiving notifications, screen mirroring, and sharing multimedia files. See [Mobile continuity](#) on page 37.



## Night mode

Use a darker theme to keep your eyes comfortable at night. See [Night mode](#) on page 106.



## Expandable storage

Expand storage with a supported microSD™ card. See [Memory card](#) on page 109.



## Security

Use biometrics to unlock your device. See [Flexible security](#) on page 35.

# Getting started

---

Front view

Back view

Assemble your device

Start using your device



# Front view



## Back view



## Assemble your device

Your device uses a nano-SIM card. A SIM card may be preinstalled, or you may be able to use your previous SIM card. Contact your carrier for more details.



Charge your device  
Before turning on your  
device, charge it fully.

 **NOTE** Use only charging devices and batteries (if applicable) that are approved by Samsung. Samsung charging devices and batteries are designed for your device to maximize battery life. Using other charging devices and batteries may void your warranty and may cause damage.



## Install cards and the battery

The SIM card, optional microSD card, and battery are installed in the back of the device.

1. Lift the cover up and to the right of the device.

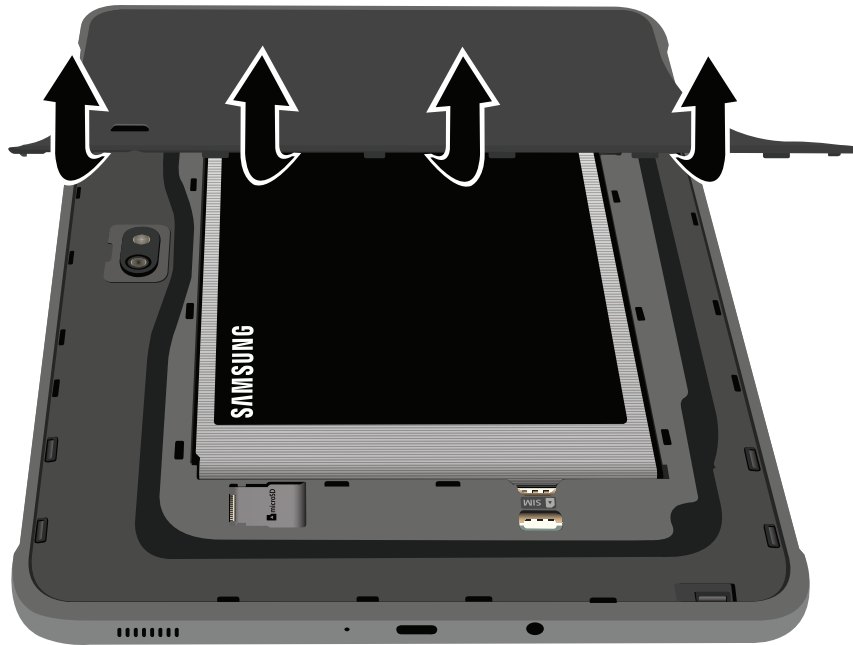

2. Carefully remove the battery.



3. Carefully slide the SIM card into the SIM card slot. Make sure that the card's gold contacts face down into the device.

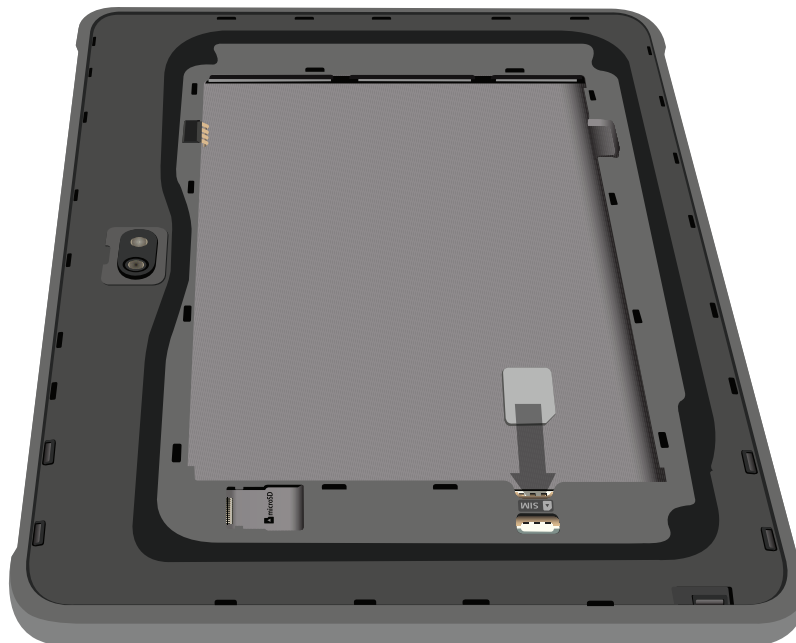

Devices and software are constantly evolving — the illustrations you see here are for reference only.

4. Slide the optional microSD card into the slot with the gold contacts facing down.

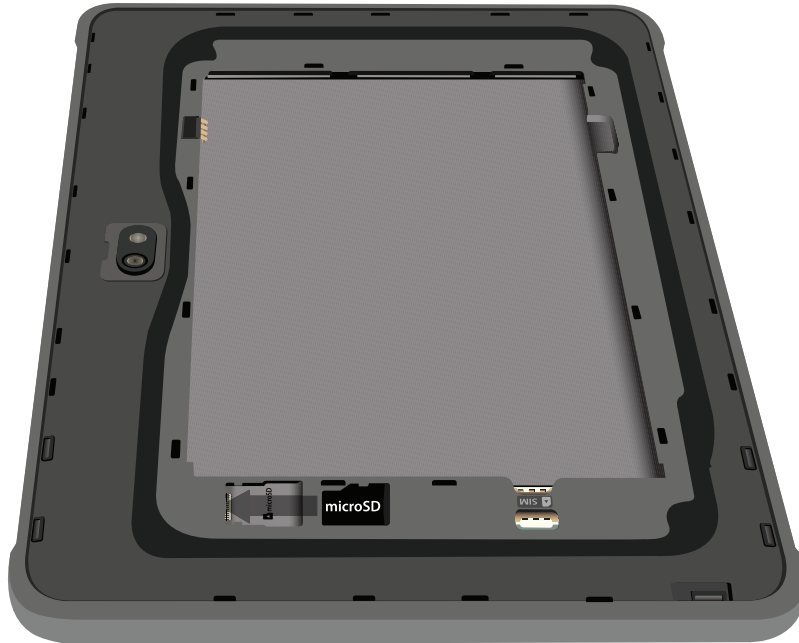

5. Insert the battery into the opening on the back of the device, making sure the connectors align.



6. Gently press down to secure the battery.
7. Place the back cover onto the back of the device and press down.

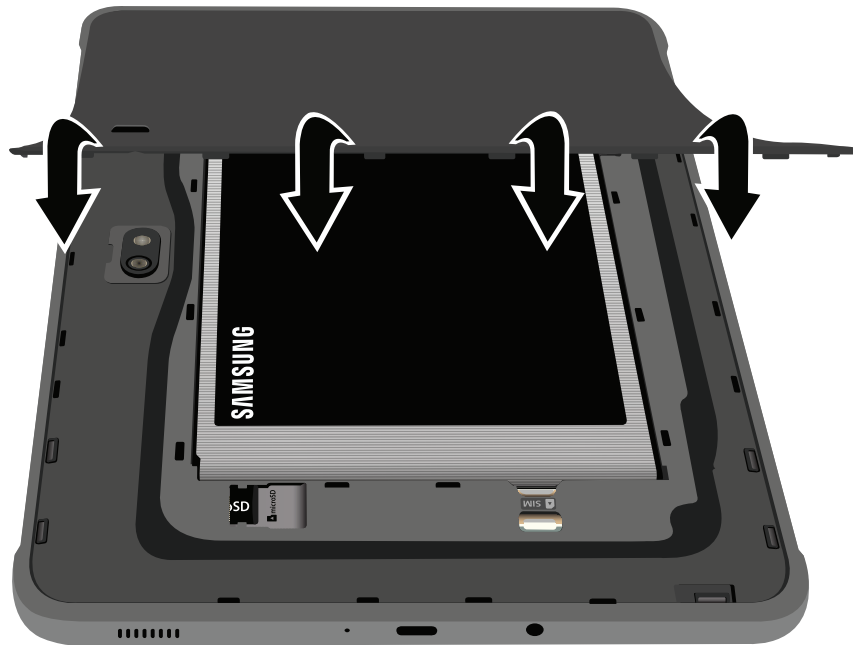

8. Press along the edge of the back cover until you have a secure seal.

## Charge the battery

Your device is powered by a rechargeable battery. A charger (charging head and USB Type-C cable) is included with the device for charging the battery from a power outlet.

 **TIP** While charging, the device and the charger may become hot and stop charging. This usually does not affect the device's lifespan or performance and is in the device's normal range of operation. Disconnect the charger from the device and wait for the device to cool down. For more information, visit [samsung.com/us/support/answer/ANS00076952](https://samsung.com/us/support/answer/ANS00076952).





## Install the bumper



Protect your device by using the bumper.



## Start using your device

Use the Side key to turn your device on. Do not use the device if the body is cracked or broken. Use the device only after it has been repaired.

- Press and hold the **Side** key to turn the device on.
  - To turn the device off, open the Notification panel, and tap  **Power** >  **Power off**. Confirm when prompted.
  - To restart your device, open the Notification panel, and tap  **Power** >  **Restart**. Confirm when prompted.

 **TIP** You can also turn your device off by pressing the **Side** and **Volume down** keys at the same time. To learn more about powering off your device from Settings, tap  **Advanced features** > **Side key** > **How to power off your tablet**.

## Use the setup wizard

The first time you turn your device on, the setup wizard guides you through the basics of setting up your device.

Follow the prompts to choose a default language, connect to a Wi-Fi® network, set up accounts, choose location services, learn about your device's features, and more.

## Lock or unlock your device

Use your device's screen lock features to secure your device. By default, the device locks automatically when the screen times out. For more information about screen locks, see [Lock screen and security](#) on page 117.

### Side key

Press to lock.

Press to turn on the screen and then swipe the screen to unlock it.



## Side key settings

You can customize the shortcuts assigned to the Side key.

### Double press

Choose an option to customize which feature is launched when the Side key is pressed twice.

1. From Settings, tap  **Advanced features** > **Side key**.
2. Tap **Double press** to enable this feature, and tap an option:
  - Quick launch camera
  - Open Bixby
  - Open app

### Press and hold

Choose an option to customize which feature is launched when the Side key is pressed and held.

1. From Settings, tap  **Advanced features** > **Side key**.
2. Under the Press and hold heading, tap an option:
  - Wake Bixby
  - Power off menu

## Active key settings

Launch your favorite applications by pressing the dedicated Active key in different ways. Press the Active key while Camera is open to take pictures.

- From Settings, tap  **Advanced features** > **Active key** for the following options:
  - **Press**: Select the app to launch with one quick press.
  - **Press and hold**: Select the app to launch with one longer press.
  - **Use while screen locked**: Use the Active key to open apps while the screen is locked.





## Accounts

Set up and manage your email accounts, your Google™ Account, and Samsung account.

 **TIP** Accounts may support email, calendars, contacts, and other features. See your carrier for more information.

### Add a Google Account



Sign in to your Google Account to access your Google cloud storage, apps installed from your account, and make full use of your device's Android™ features.



1. From Settings, tap  **Accounts and backup** > **Accounts**.
2. Tap  **Add account** > **Google**.

 **NOTE** When you sign in to a Google Account, Factory Reset Protection (FRP) is activated. FRP requires your Google Account information when resetting to factory settings. For more information, see [Factory reset protection](#) on page 116.

### Add a Samsung account



Sign in to your Samsung account to access exclusive Samsung content and make full use of Samsung apps.

1. From Settings, tap  **Accounts and backup** > **Accounts**.
2. Tap  **Add account** > **Samsung account**.

 **TIP** To quickly access your Samsung account, from Settings tap  **Samsung account**.

### Add an Outlook account

Sign in to your Outlook® account to view and manage email messages.

1. From Settings, tap  **Accounts and backup** > **Accounts**.
2. Tap  **Add account** > **Outlook**.

## Transfer data from an old device

Use Smart Switch™ to transfer contacts, photos, music, videos, messages, notes, calendars, and more from your old device. Smart Switch can transfer your data via USB cable, Wi-Fi, or computer.

Visit [samsung.com/us/support/owners/app/smart-switch](https://samsung.com/us/support/owners/app/smart-switch) to learn more.

1. From Settings, tap  **Accounts and backup** > **Smart Switch**.
2. Follow the prompts and select the content to transfer.

Visit [samsung.com/smartswitch](https://samsung.com/smartswitch) for more information.

## Navigation

A touch screen responds best to a light touch from the pad of your finger or a capacitive stylus. Using excessive force or a metallic object on the touch screen may damage the tempered glass surface and void the warranty.

### Tap

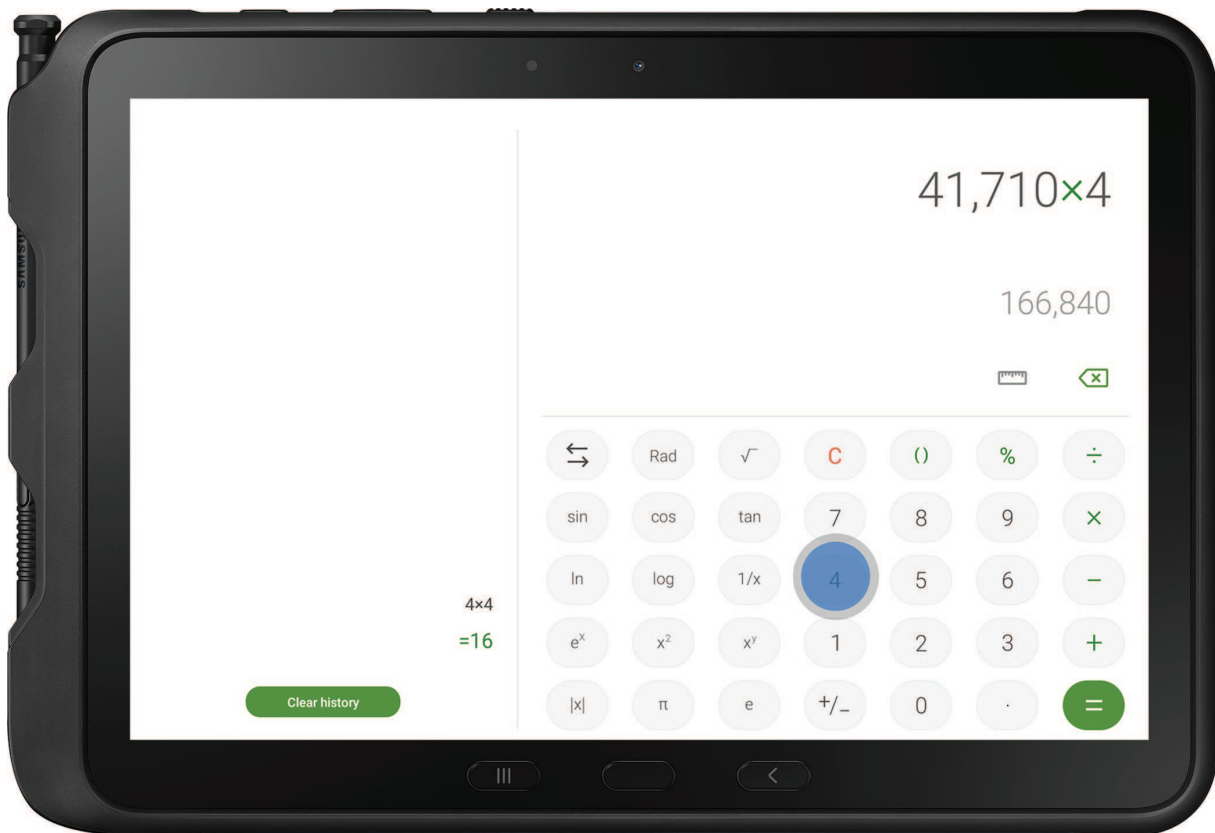

Lightly touch items to select or launch them.

- Tap an item to select it.
- Double-tap an image to zoom in or out.

## Swipe

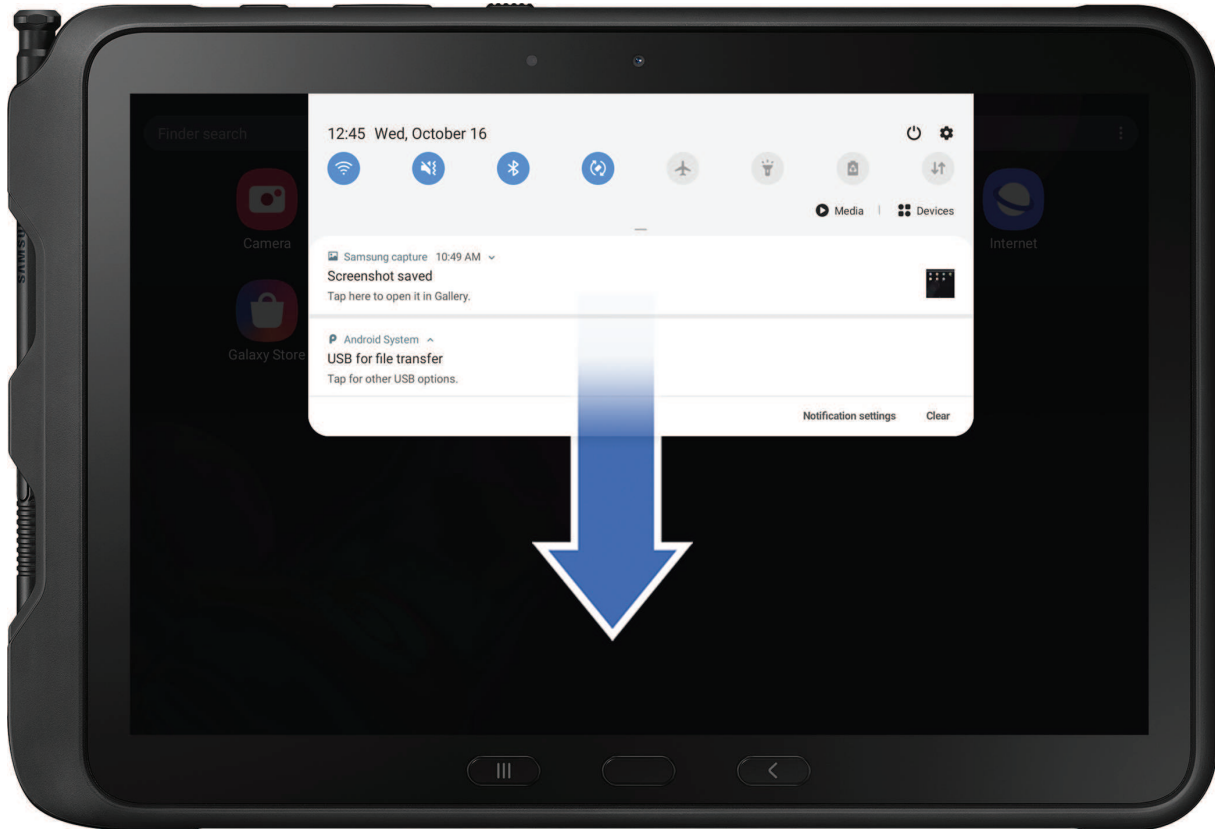

Lightly drag your finger across the screen.

- Swipe the screen to unlock the device.
- Swipe the screen to scroll through the Home screens or menu options.

## Drag and drop



Touch and hold an item, and then move it to a new location.

- Drag an app shortcut to add it to a Home screen.
- Drag a widget to place it in a new location.

## Zoom in and out



Bring your thumb and forefinger together or apart to zoom in and out.

- Bring your thumb and forefinger together on the screen to zoom out.
- Move your thumb and forefinger apart on the screen to zoom in.

## Touch and hold

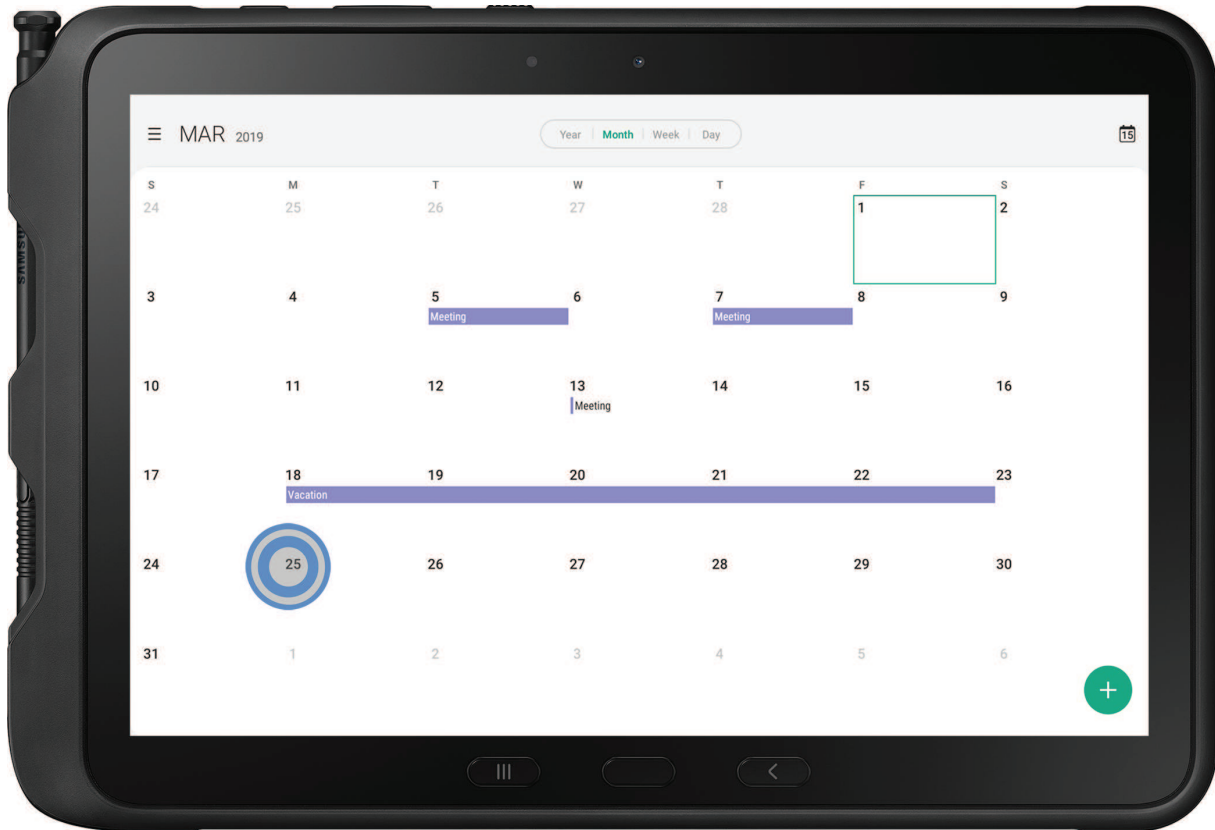

Touch and hold items to activate them.

- Touch and hold a field to display a pop-up menu of options.
- Touch and hold a Home screen to customize the Home screen.

## Customize your home screen

The Home screen is the starting point for navigating your device. You can place your favorite apps and widgets here. You can set up additional Home screens, remove screens, change the order of screens, and choose a main Home screen.

### App icons

You can use app icons to launch an app from any Home screen.

- From Apps, touch and hold an app icon, and tap  **Add to Home**.

To remove an icon:

- Touch and hold an app icon, and tap  **Remove from Home**.

 **NOTE** Removing an icon does not delete the app, it just removes the icon from a Home screen.

### Use folders

Organize App shortcuts in folders on an Apps screen or Home screen.

For more information, see [Create and use folders](#) on page 46.

### Wallpapers

You can change the look of the Home and Lock screens by choosing a favorite picture or preloaded wallpaper.

1. From a Home screen, touch and hold the screen.
2. Tap  **Wallpapers**.
3. Tap an image to choose it.
  - Tap the screen or screens to which you want to apply the wallpaper.
4. Tap **Set as wallpaper**, and confirm when prompted.





## Widgets

Add widgets to your home screens for quick access to info or apps.

1. From a Home screen, touch and hold the screen.
2. Tap  **Widgets**, and then touch and hold a widget, drag it to a Home screen, and release it.

## Customize Widgets

Once you have added a widget, you can customize where it's located and how it functions.

- From a Home screen, touch and hold a widget, and tap an option:
  -  **Remove from Home**: Delete a widget from your screen.
  -  **Widget settings**: Customize the function or appearance of the widget.
  -  **App info**: Review the widget usage, permissions, and more.

## Home screen settings

Customize your Home and Apps screens.

1. From a Home screen, touch and hold the screen.
2. Tap  **Home screen settings** to customize:
  - **Home screen layout**: Set your device to have separate Home and Apps screens, or only a Home screen where all apps are located.
  - **Home screen grid**: Choose a layout to determine how icons are arranged on the Home screen.
  - **Apps screen grid**: Choose a layout to determine how icons are arranged on the Apps screen.
  - **Apps button**: Add a button to the Home screen for easy access to the Apps screen.
  - **App icon badges**: Enable to show badges on apps with active notifications. You can also choose the badge style.
  - **Lock Home screen layout**: Prevent items on the Home screen from being removed or repositioned.

- **Add apps to Home screen:** Automatically add newly-downloaded apps to the Home screen.
- **Swipe down for notification panel:** Enable this feature to open the Notification panel by swiping down anywhere on the Home screen.
- **Hide apps:** Choose apps to hide from the Home and App screens. Return to this screen to restore hidden apps. Hidden apps are still installed and can appear as results in Finder searches.
- **About Home screen:** View version information.

## Status bar

The Status bar provides device information on the right side and notification alerts on the left.

### Status icons



Battery full



Battery low



Charging



Mute



Vibrate



Airplane mode



Bluetooth active



Wi-Fi active



Location active



Alarm

### Notification icons



New email



Download



Upload



Wi-Fi available



App update

Configure display options for the Status bar.

- From Quick settings, tap **More options** > **Status bar** for the following options:
  - **Show notification icons:** Choose how to display notification icons on the Status bar.
  - **Show battery percentage:** Display the battery charge percentage next to the battery icon on the Status bar.

## Notification panel

For quick access to notifications, settings, and more, simply open the Notification panel.

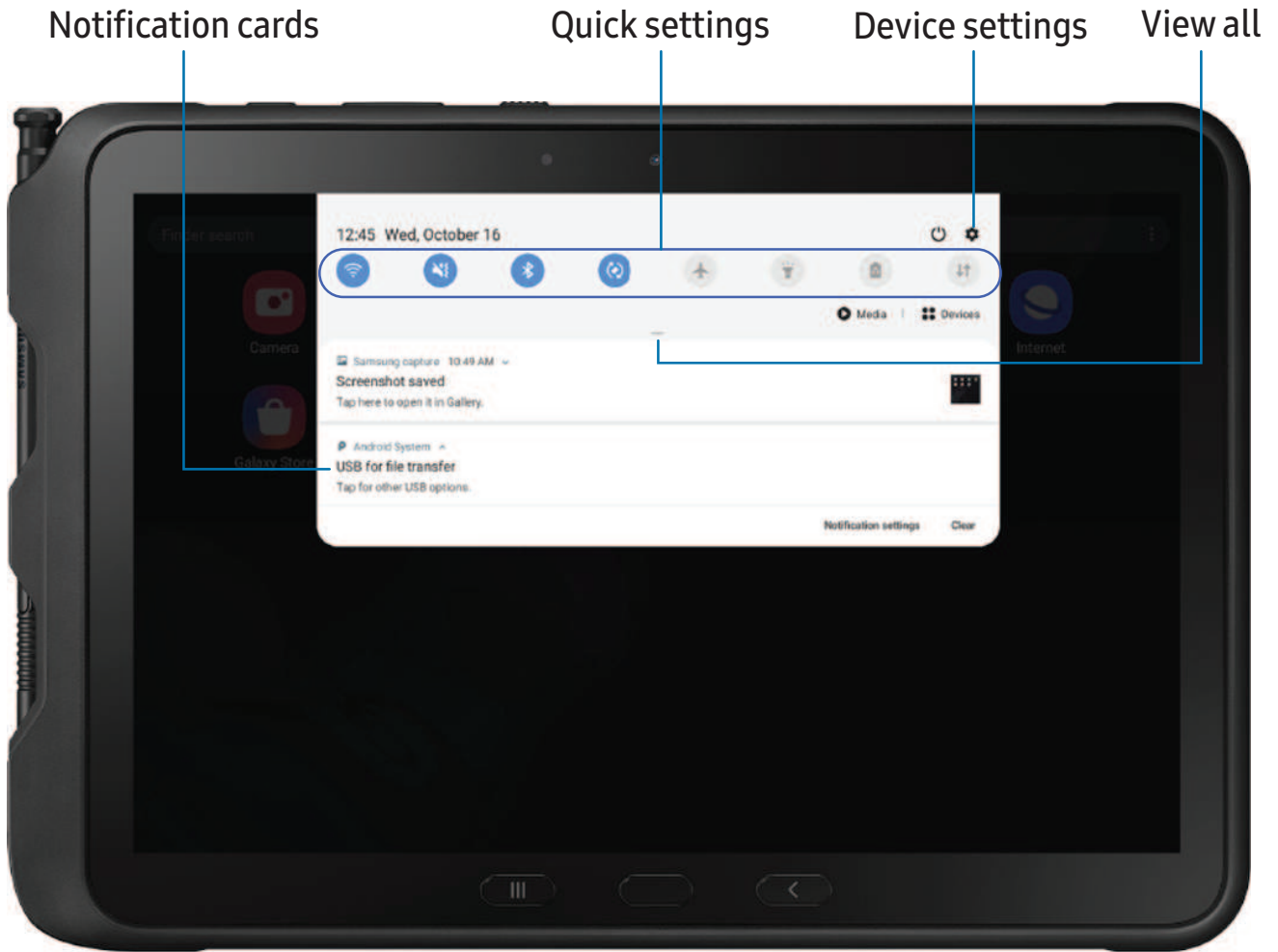



## View the Notification panel

You can access the Notification panel from any screen.

1. Drag the Status bar down to display the Notification panel.
2. Swipe down the list to see notification details.
  - To open an item, tap it.
  - To clear a single notification, drag the notification left or right.
  - To clear all notifications, tap **Clear**.
  - To customize notifications, tap **Notification settings**.
3. Drag upward from the bottom of the screen or tap  **Back** to close the Notification panel.

## Quick settings

The Notification panel also provides quick access to device functions using Quick settings.

1. Drag the Status bar down to display the Notification panel.
2. Drag — **View all** downward.
  - Tap a quick setting icon to turn it on or off.
  - Touch and hold a quick setting icon to open the setting.
  - Tap  **Search** to search the device.
  - Tap  **Settings** to quickly access the device's settings menu.
  - Tap  **More options** to reorder Quick settings or to change the button layout.
3. Drag — **View all** upward to close Quick settings.

## S Pen

The S Pen provides a variety of helpful functions. Use your S Pen to launch apps, take notes, or draw a picture.



### Air view

Hover the S Pen over the screen to preview content or view information about an item on the screen. The following Air view features are available:





- Preview an email message before opening it.
- Preview the contents of a photo album or enlarge a picture.
- Preview a video and navigate to a specific scene by hovering over the timeline.
- View the name or description of an icon or a button.





 **NOTE** The preview function is only available when the S Pen's on-screen pointer is a solid color.

## Air command



Settings

1. Tap  **Air command** or hold the S Pen near the screen so that the pointer appears, and then press the S Pen button once.
2. Tap an option:
  -  **Create note**: Launch a new note in the Samsung Notes app.
  -  **View all notes**: Launch the Samsung Notes app and view a listing of the notes you have created.
  -  **Smart select**: Draw around an area of the screen to collect it in the Gallery app.

-  **Screen write:** Capture screenshots and write or draw on them.
-  **Live message:** Create a short animated message by drawing or writing with the S Pen.
-  **PENUP:** Use the S Pen to draw, color, edit, and share live drawings.
-  **Add shortcuts:** Add more apps or functions to the Air command menu.
-  **Settings:** Customize Air command by configuring apps and functions, and by changing how the Air command menu appears.

### Create note

Launch a new note directly in the Samsung Notes app. For more information, see **Samsung Notes** on page 50.

- Tap  **Air command** >  **Create note.**







### View all notes



Launch the Samsung Notes app and view a listing of the notes you have created.

- Tap  **Air command** >  **View all notes.**

### Smart select

The Smart select feature allows you to copy content from any screen. You can then add it to your Gallery app or share it with your contacts.



1. Tap  **Air command** >  **Smart select.**
2. Tap a shape in the menu, and then drag the S Pen to select content. The following options appear:
  - **Extract text:** Identify and extract text from the selected content.
  -  **Auto select:** Allow Smart select to automatically select content to extract.
  -  **Draw:** Draw on the captured content.
  -  **Share:** Choose a sharing method to share your content.
3. Tap  **Save.**

 **TIP** You can tap  **GIF** to record an animation or **Pin** to pin the content to your screen using Smart select.



## Screen write



Screen write allows you to capture screenshots and write or draw on them.

1. Tap  **Air command** >  **Screen write**.
2. The current screen is captured, and a pen tool appears. The following editing tools are provided:
  - **Crop**: Drag the edges of the screen to crop the captured content.
  - **Undo**: Reverse the last action.
  - **Redo**: Repeat the last action that was undone.
  - **Share**: Choose a sharing method to share your content.
3. Tap **Save**. The content is saved to the Gallery app.

 **TIP** Hold the **S Pen** button to erase your drawings on the screen memo.

## Live message

Record an animated drawing or written message.

1. Tap  **Air command** >  **Live message**.
2. Draw an image or write a message, which is recorded to create an animation.
3. Tap **Done** to save.



## PENUP

Use the S Pen to draw, color, edit, and share live drawings. For more information, see **PENUP** on page 48.

- Tap  **Air command** >  **PENUP**.



## Add shortcuts

You can customize the Air command menu by adding shortcuts to apps and functions.

1. Tap  **Air command** >  **Add shortcuts**.
2. Tap the apps or functions you would like to add to the Air command menu.
  - To remove an app shortcut, tap  **Remove**.
3. Tap **Back** to save your selection.

## Screen off memo

You can write memos without turning your screen on. The screen off memo setting must be enabled. For more information, see **Configure S Pen settings** below.

1. Press the S Pen button and tap the screen while the screen is off.
2. Write or draw on the screen.
3. Tap an option to customize your memo:
  -  **Color**: Change the pen color.
  -  **Pen**: Tap to use the pen tool. Double tap to adjust the line thickness.
  -  **Eraser**: Tap to use the eraser tool. Double tap to erase all.
4. Tap **Save in Notes** to save your memo to the Samsung Notes app.

## Configure S Pen settings

To configure S Pen settings:

- From Settings, tap  **Advanced features** > **S Pen** to configure the following settings:
  - **Screen off memo**: Create memos without turning on the screen. Screen off memos are saved in Samsung Notes.
  - **Air view**: Turn Air view on or off.
  - **Pointer**: Turn the pointer on or off. The pointer appears on the screen when the tip of the S Pen is near the screen, showing available actions.

## **Air Command**

- **Shortcuts:** Configure the Air command menu with S Pen features, apps, and functions.
- **Floating icon:** Show an Air command icon that you can move around the screen.

## **Feedback**

- **Sound:** Set your device to make sounds when writing on the screen.

## **General**

- **Learn about S Pen features:** Find out how to use S Pen features.
- **About S Pen features:** View version information for the S Pen features.

## Replace the S Pen tip

If the S Pen tip becomes worn, you can replace it with a new one, using the included kit.

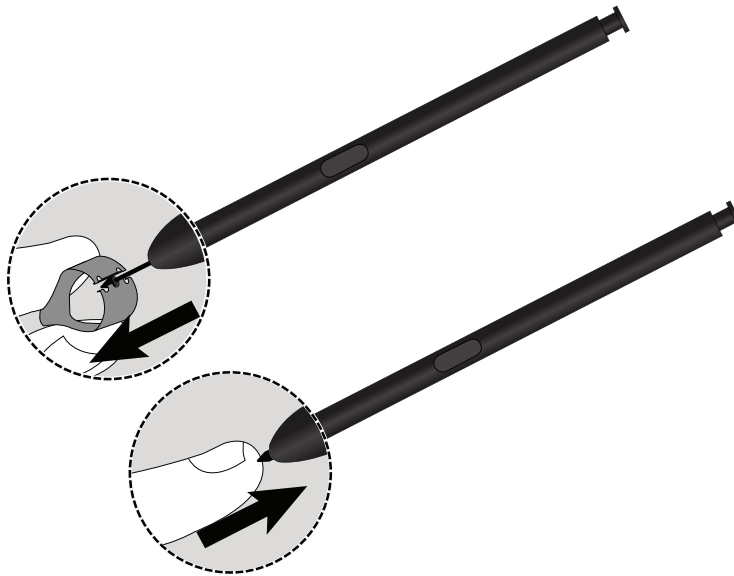

## Bixby

Bixby is a virtual assistant that learns, evolves, and adapts to you. It learns your routines, helps you set up reminders based on time and location, and is built in to your favorite apps. Visit [samsung.com/us/support/owners/app/Bixby](https://samsung.com/us/support/owners/app/Bixby) for more information.

The Bixby Home page displays customized content based on your interactions. Bixby learns from your usage patterns and will suggest content you may like.

- From a Home screen, swipe right or press and hold the **Side** key.

 **TIP** You can also access Bixby from the Apps list.

## Bixby Routines

You can use Bixby to show you information or change device settings based on where you are and what you are doing.

- From Settings, tap  **Advanced features** > **Bixby Routines**.

## Bixby Vision

Bixby is integrated with your Camera, Gallery, and Internet apps to give you a deeper understanding of what you see. It provides contextual icons for translation, QR code detection, landmark recognition, or shopping.



### Camera

Bixby Vision is available on the Camera viewfinder to help understand what you see.

- From  **Camera**, tap **Bixby Vision** and follow the prompts.

### Gallery

Bixby Vision can be used on pictures and images saved in the Gallery app.

1. From  **Gallery**, tap a picture to view it.
2. Tap  **Bixby Vision** and follow the prompts.

### Internet

Bixby Vision can help you find out more about an image you find in the Internet app.

1. From  **Internet**, touch and hold an image until a pop-up menu is displayed.
2. Tap **Bixby Vision** and follow the prompts.

## Digital wellbeing

You can monitor and manage your digital habits by getting a daily view of how frequently you use apps, how many notifications you receive, and how often you check your device. You can also set your device to help you wind down before going to bed.

- From Settings, tap  **Digital wellbeing**.
  - **Screen time:** Tap the time value in the dashboard circle for details on how long each app has been opened and used today.
  - **Unlocks:** Tap to see how many times each app has been opened today.
  - **Notifications:** Tap to see how many notifications have been received from each app today.
  - **Dashboard:** View all dashboard information shown above. Each app can have a timer set to limit usage throughout the day.

- **Wind down:** Enable to turn the screen to grayscale and limit notifications before going to bed.
- **Notifications:** Configure notification settings for each app.

## Flexible security

Use biometrics to securely unlock your device and log in to accounts.

### Face recognition

You can enable Face recognition to unlock your screen. To use your face to unlock your device, you must set a pattern, PIN, or password.

- Face recognition is less secure than Pattern, PIN, or Password. Your device could be unlocked by someone or something that looks like your image.
  - Some conditions may affect face recognition, including wearing glasses, hats, beards, or heavy make-up.
  - When registering your face, ensure that you are in a well-lit area and the camera lens is clean.
1. From Settings, tap  **Biometrics and security** > **Face recognition**.
  2. Follow the prompts to register your face.

### Face recognition management

Customize how face recognition works.

- From Settings, tap  **Biometrics and security** > **Face recognition**.
  - **Remove face data:** Delete existing faces.
  - **Face unlock:** Enable or disable face recognition security.
  - **Stay on Lock screen:** When you unlock your device with face recognition, stay on the Lock screen until you swipe the screen.
  - **Faster recognition:** Turn on for faster face recognition. Turn off to increase security and make it harder to unlock using an image or video of your likeness.

- **Brighten screen:** Increase the screen brightness temporarily to improve recognition in dark conditions.
- **Samsung Pass:** Allow Samsung Pass to use face recognition.

### Fingerprint scanner

Use fingerprint recognition as an alternative to entering passwords in certain apps. You can also use your fingerprint to verify your identity when logging in to your Samsung account. To use your fingerprint to unlock your device, you must set a pattern, PIN, or password.

1. From Settings, tap  **Biometrics and security** > **Fingerprints**.
2. Follow the prompts to register your fingerprint.

### Fingerprint management

Add, delete, and rename fingerprints.

- From Settings, tap  **Biometrics and security** > **Fingerprints** for the following options:
  - The list of registered fingerprints is at the top of this list. You can touch and hold a fingerprint to remove or rename it.
  - **Add fingerprint:** Simply follow the prompts to register another fingerprint.
  - **Check added fingerprints:** Scan your fingerprint to see if it has been registered.

### Fingerprint verification settings

Use fingerprint recognition to verify your identity in supported apps and actions.

- From Settings, tap  **Biometrics and security** > **Fingerprints**.
  - **Fingerprint unlock:** Use your fingerprint for identification when unlocking your device.
  - **Samsung Pass:** Use your fingerprint for identification when using supported apps.

## Biometrics Preferences

Configure your preferences for biometric security options.



- From Settings, tap  **Biometrics and security** > **Biometrics preferences**:
  - **Preferred biometric**: Choose your preferred biometric. Only biometrics that have already been set up are listed.
  - **Screen transition effect**: Show a transition effect when you use biometrics to unlock your device.

## Mobile continuity

Phone calls, messages, photo and video storage, and other functions of your device can be accessed and integrated across compatible mobile devices and computers.

## Call & text on other devices



This feature allows you to make and answer calls and text messages from your Galaxy devices that are signed in to your Samsung account.

1. From Settings, tap  **Advanced features** > **Call & text on other devices**.
2. Tap  to turn on the feature. Connection occurs automatically.
3. Sign in to your Samsung account on your Galaxy devices.

 **TIP** Move your contacts from your phone to your Samsung account so you can access them on all registered devices.

## Samsung DeX

Use a full desktop interface on your tablet. You can use larger screens with an HDMI cable. The tablet automatically enters DeX mode when a POGO keyboard is attached (sold separately).

1. From Settings, tap  **Advanced features** > **Samsung DeX**.
2. Tap  to enable the feature and follow the prompts.



## Multi window

Multitask by using multiple apps at the same time. Apps that support Multi window™ can be displayed together on a split screen. You can switch between the apps and adjust the size of their windows.

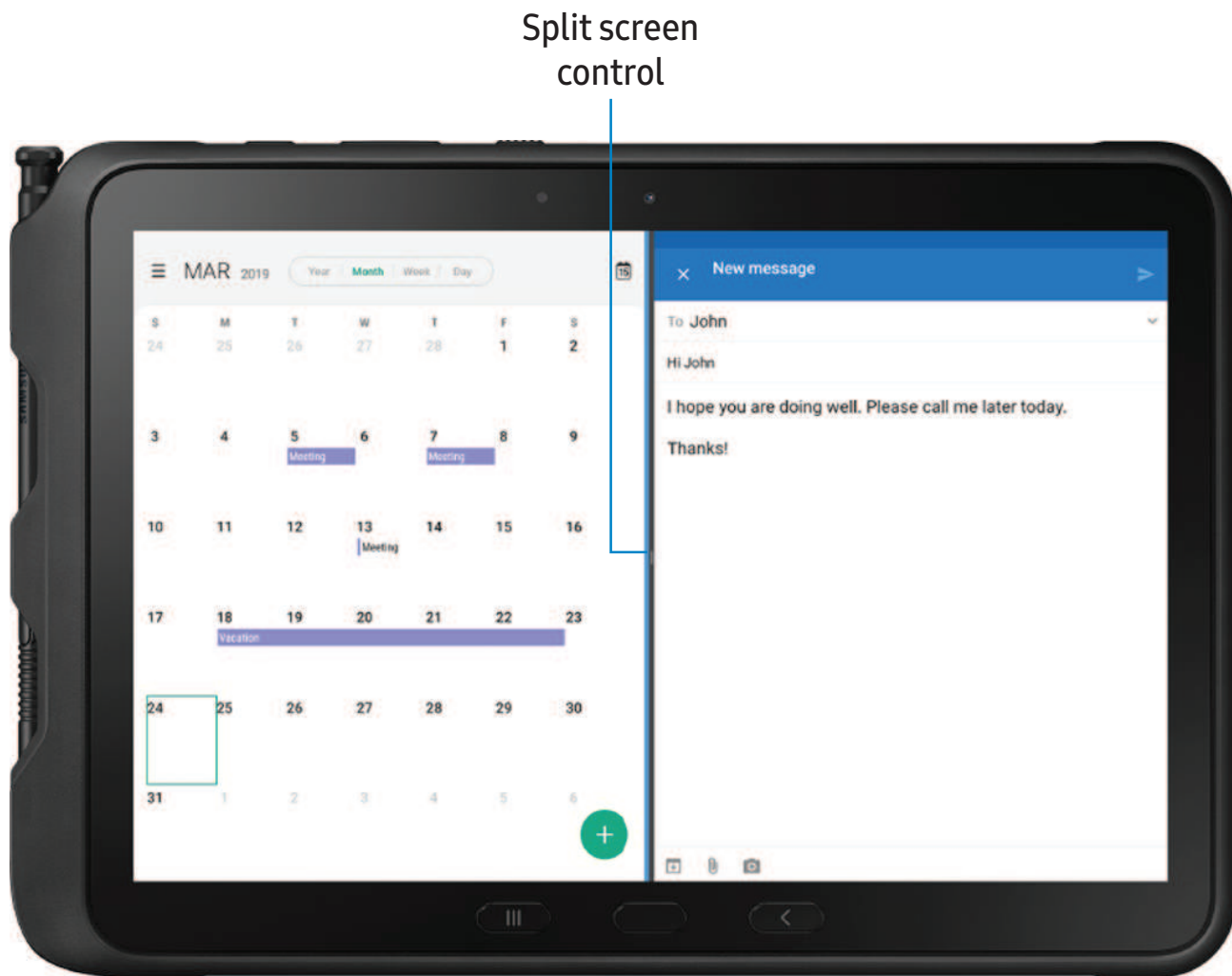

1. From any screen, tap **Recent apps**.
2. Tap the app icon, and then tap **Open in split screen view**.
3. Tap an app in the other window to add it to the split screen view.
  - Drag the middle of the window border to adjust the window size.

## Multi window tray



Quickly launch an app in split screen view. To enable Multi window tray:

1. From Settings, tap  **Advanced features** > **Multi window tray**.
2. From any Home screen or supported app, swipe from the right edge of the screen to open the Multi window tray.
3. Tap an app to open it in split screen view.

## Enter text

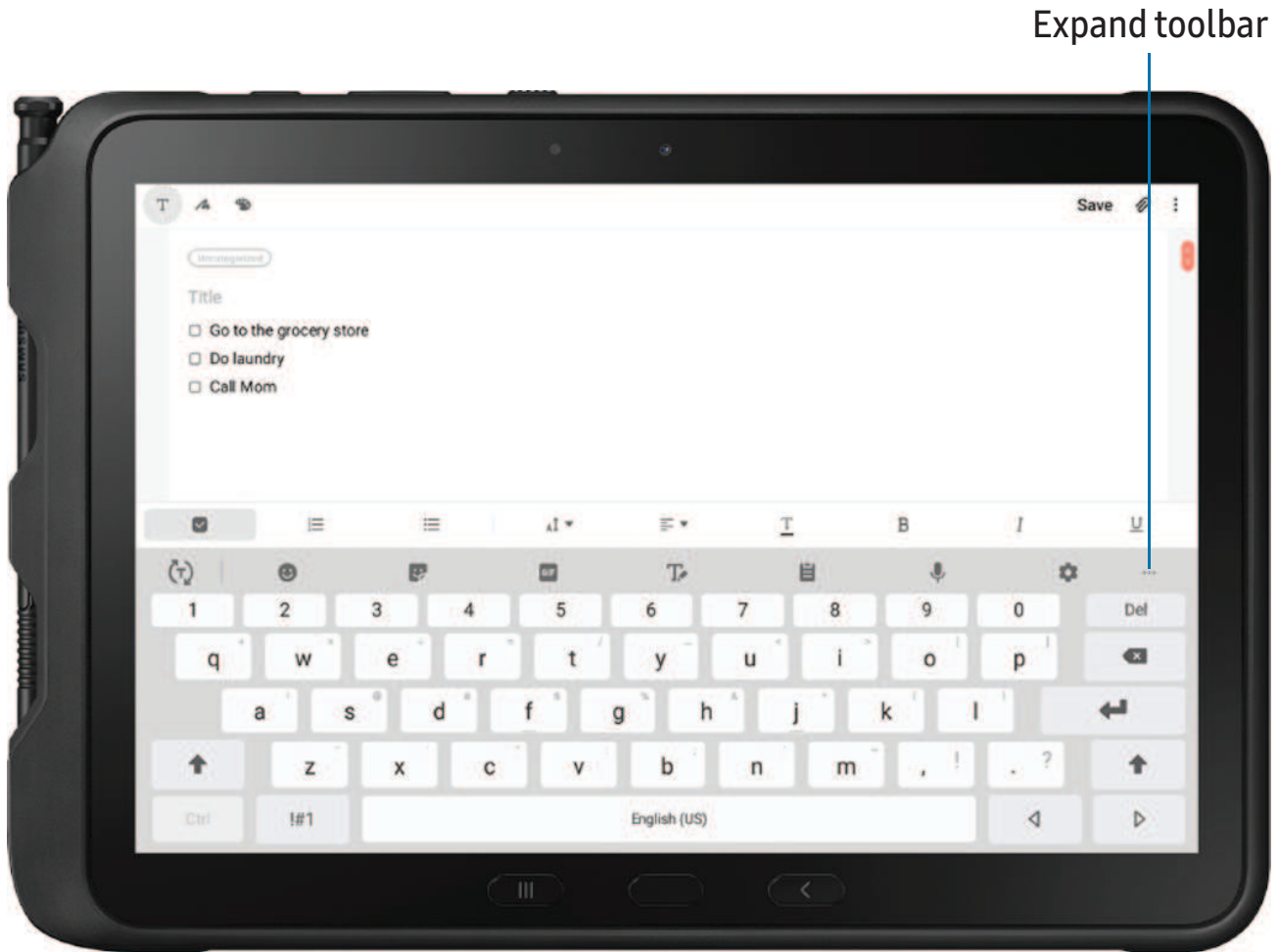







Text can be entered using a keyboard or your voice.



- Tap a field to display the Samsung keyboard.
  - Tap  Show predictive text to view suggested words while you type.
  - Tap  Show toolbar functions to view all keyboard options.

## Toolbar functions

The toolbar provides additional helpful functions.

- From the Samsung keyboard, tap **⋮ Expand toolbar** for the following options:
  -  **Clipboard**: Access the clipboard.
  -  **Emojis**: Insert an emoji.
  -  **GIF keyboard**: Add animated GIFs.
  -  **Handwriting**: Use your handwriting to enter text.
  -  **Modes**: Select a keyboard layout.
  -  **Settings**: Access keyboard settings.
  -  **Stickers**: Add illustrated stickers.
  -  **Text editing**: Use an editing panel to help pinpoint text that you want to cut, copy, and paste.
  -  **Voice input**: Use Google Voice™ typing.

## Configure the Samsung keyboard

Set customized options for the Samsung keyboard.

- From the Samsung keyboard, tap  **Settings** for the following options:
  - **Languages and types**: Set the keyboard type and choose which languages are available on the keyboard.
    - To switch between languages, slide the Space bar sideways.
  - **Smart typing**: Use predictive text and auto-correction features to prevent common typing mistakes. Type by swiping between letters.
  - **Style and layout**: Customize the appearance and function of the keyboard.
  - **Swipe, touch, and feedback**: Customize gestures and feedback.
  - **Reset to default settings**: Return keyboard to original settings and clear personalized data.
  - **About Samsung keyboard**: View version and legal information for the Samsung keyboard.

## Use Google Voice typing

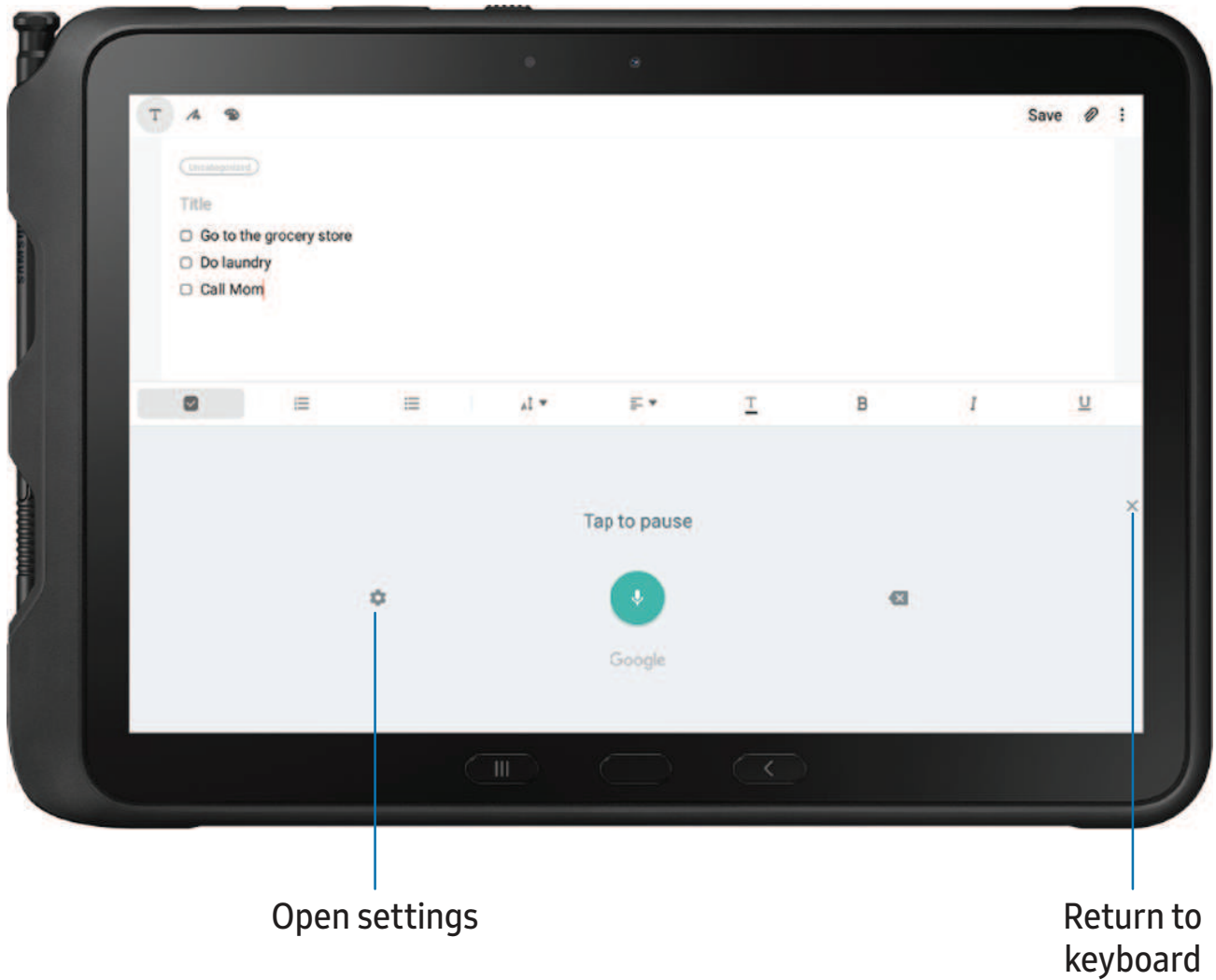

Instead of typing, enter text by speaking.



1. From the Samsung keyboard, tap  Voice input.
2. Tap the screen and speak your text.

## Configure Google Voice typing

Set customized options for Google Voice typing.

1. From the Samsung keyboard, tap  **Voice input**.
2. Tap  **Settings** for options.
  - **Languages:** Choose the language for the keyboard.
  - **Offline speech recognition:** Download languages for offline Google Voice typing.
  - **Hide offensive words:** Hide potentially offensive words with asterisks.

# Apps

---

Using apps

Samsung apps

Google apps

Microsoft apps

Additional apps



# Using apps

The Apps list displays all preloaded and downloaded apps. Apps can be downloaded from Galaxy Store and the Google Play™ store.

- From a Home screen, swipe the screen upward to access the Apps list.

## Uninstall or disable apps



Installed apps can be removed from your device. Some apps that are preloaded (available on your device by default) can only be disabled. Disabled apps are turned off and hidden from the Apps list.

- From Apps, touch and hold an app, and tap **Uninstall/Disable**.

## Search for apps

If you are not sure where to find an app or a setting, you can use the Search feature.



1. From Apps, tap **Finder search**, and enter a word or words. As you type, matching apps and settings appear as results on the screen.
2. Tap a result to go to that app.

 **TIP** You can customize the search settings by tapping  **More options** > **Finder settings**.

## Sort apps

App shortcuts can be listed alphabetically or in your own custom order.



- From Apps, tap  **More options** > **Sort** for the following sorting options:
  - **Custom order**: Arrange apps manually.
  - **Alphabetical order**: Sort apps alphabetically.

 **TIP** When apps are arranged manually (Custom order), empty icon spaces can be removed by tapping  **More options** > **Clean up pages**.



## Create and use folders

You can make folders to organize App shortcuts on the Apps list.

1. From Apps, touch and hold an app shortcut, and then drag it on top of another app shortcut until it is highlighted.
2. Release the app shortcut to create the folder.
  - **Enter folder name:** Name the folder.
  -  **Palette:** Change the folder color.
  -  **Add apps:** Place more apps in the folder. Tap apps to select them, and then tap **Add**.
3. Tap  **Back** to close the folder.

## Copy a folder to a Home screen

You can copy a folder to a Home screen.

- From Apps, touch and hold a folder, and tap  **Add to Home**.



## Delete a folder

When you delete a folder, the app shortcuts return to the Apps list.

1. From Apps, touch and hold a folder to delete.
2. Tap  **Delete folder**, and confirm when prompted.

## App settings

Manage your downloaded and preloaded apps. Options vary by app.

1. From Settings, tap  **Apps**.
2. Tap  **Menu** to set which apps to view, and then choose **All**, **Enabled**, or **Disabled**.
3. Tap  **More options** for the following options:
  - **Sort by:** Sort the apps by size, name, last used, or last updated.
  - **Default apps:** Choose or change apps that are used by default for certain features, like email or browsing the Internet.

- **App permissions:** Control which apps have permissions to use certain features of your device.
  - **Show/Hide system apps:** Show or hide system (background) apps.
  - **Special access:** Select which apps can have special access permissions to features on your device.
  - **Reset app preferences:** Reset options that have been changed. Existing app data is not deleted.
4. Tap an app to view and update information about the app. The following options may be displayed:
- **Uninstall/Disable:** Uninstall or disable the app. Some preloaded apps can only be disabled, not uninstalled.
  - **Force stop:** Stop an app that is not working correctly.
  - **Mobile data:** View mobile data usage.
  - **Battery:** View battery usage since the last full charge.
  - **Storage:** Manage the app's storage usage.
  - **Memory:** View memory usage.
  - **Notifications:** Configure notifications from the app.
  - **Permissions:** View permissions granted to the app for access to your device's information.
  - **Set as default:** Set the app as a default for a certain category of apps.

## Samsung apps

The following apps are either preloaded or downloaded over-the-air to your device during setup.

### Galaxy Essentials

Galaxy Essentials is a collection of specially chosen applications available through Samsung apps. You can access and download a collection of premium content.

- From Apps, tap  **More options** > **Galaxy Essentials**.



Bixby displays customized content based on your interactions. Bixby learns from your usage patterns and suggests content you may like.

For more information, see **Bixby** on page 33.

- From Apps, tap  **Bixby**.



Find and download premium apps that are exclusive to Galaxy devices. A Samsung account is required to download from Galaxy Store.

- From Apps, tap **Samsung** folder >  **Galaxy Store**.



Share photos, comment on other creations, or just browse through the pages for something to add to your personal collection. This community brings together anyone that uses the S Pen to draw, sketch, scribble or paint.

- From Apps, tap **Samsung** folder >  **PENUP**.

## Samsung Flow

Connect your phone and tablet with Samsung Flow. You can then view notifications and reply to messages from your phone on your connected tablet. You can also use Mobile hotspot to access the Internet on your tablet through your phone's network connection when other networks are not available.



For more information, visit [samsung.com/us/support/owners/app/samsung-flow](https://samsung.com/us/support/owners/app/samsung-flow).

- From Apps, tap Samsung folder >  Samsung Flow.

## Samsung Notes

Use Samsung Notes to create notes containing text, images with footnotes, voice recordings, and music. You can share your notes easily using social networking services.

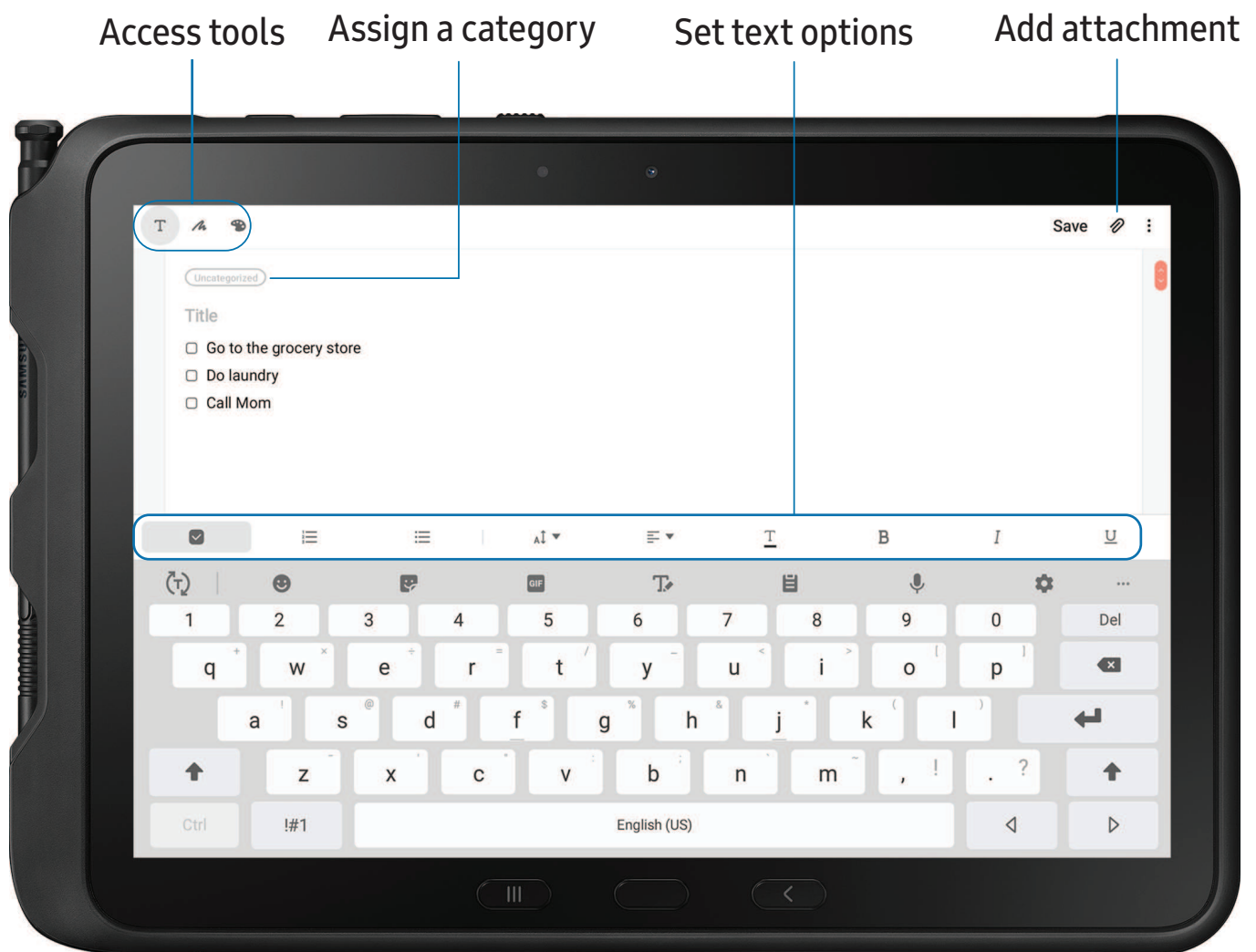

Visit [samsung.com/us/support/owners/app/samsung-notes](https://samsung.com/us/support/owners/app/samsung-notes) to learn more.

- From Apps, tap  Samsung Notes >  Create.





## Edit notes

Make edits to notes you create.

1. From  **Samsung Notes**, tap a note to view it.
2. Tap  **Edit**, and make changes. When you are finished, tap **Save**.



## Notes options

You can edit, sort, or manage notes.

- From  **Samsung Notes**, tap  **More options** for the following options:
  - **Edit**: Select notes to share, delete, or move.
  - **Sort**: Change the way notes are organized.
  - **View**: Switch between Grid, List, or Simple list.

## Notes menu

You can view your notes by category.

- From  **Samsung Notes**, tap  **Menu** for the following options:
  - **All notes**: View all notes.
  - **Frequently used**: Quick access to commonly used notes.
  - **Shared notebooks**: View notebooks shared with your contacts through your Samsung account.
  - **Trash**: View deleted notes.
  - **Categories**: View notes by category.
  -  **Settings**: View settings for the Samsung Notes app.



## SmartThings

SmartThings allows you to control, automate, and monitor your home environment through a mobile device to fit your specific needs. You can use the app to connect multiple devices at once or one device at a time. Check the status of your devices by looking at the dashboard.

- From Apps, tap **Samsung** folder >  **SmartThings**, and sign in with your Samsung account.

 **NOTE** Non-Samsung connected device errors or defects are not covered by the Samsung warranty; contact the non-Samsung device manufacturer for support.

## Calculator

The Calculator app features both basic and scientific math functions, as well as a unit converter.

- From Apps, tap  Calculator.





# Calendar

The Calendar app can be connected to your various online accounts to consolidate all your calendars in one place.

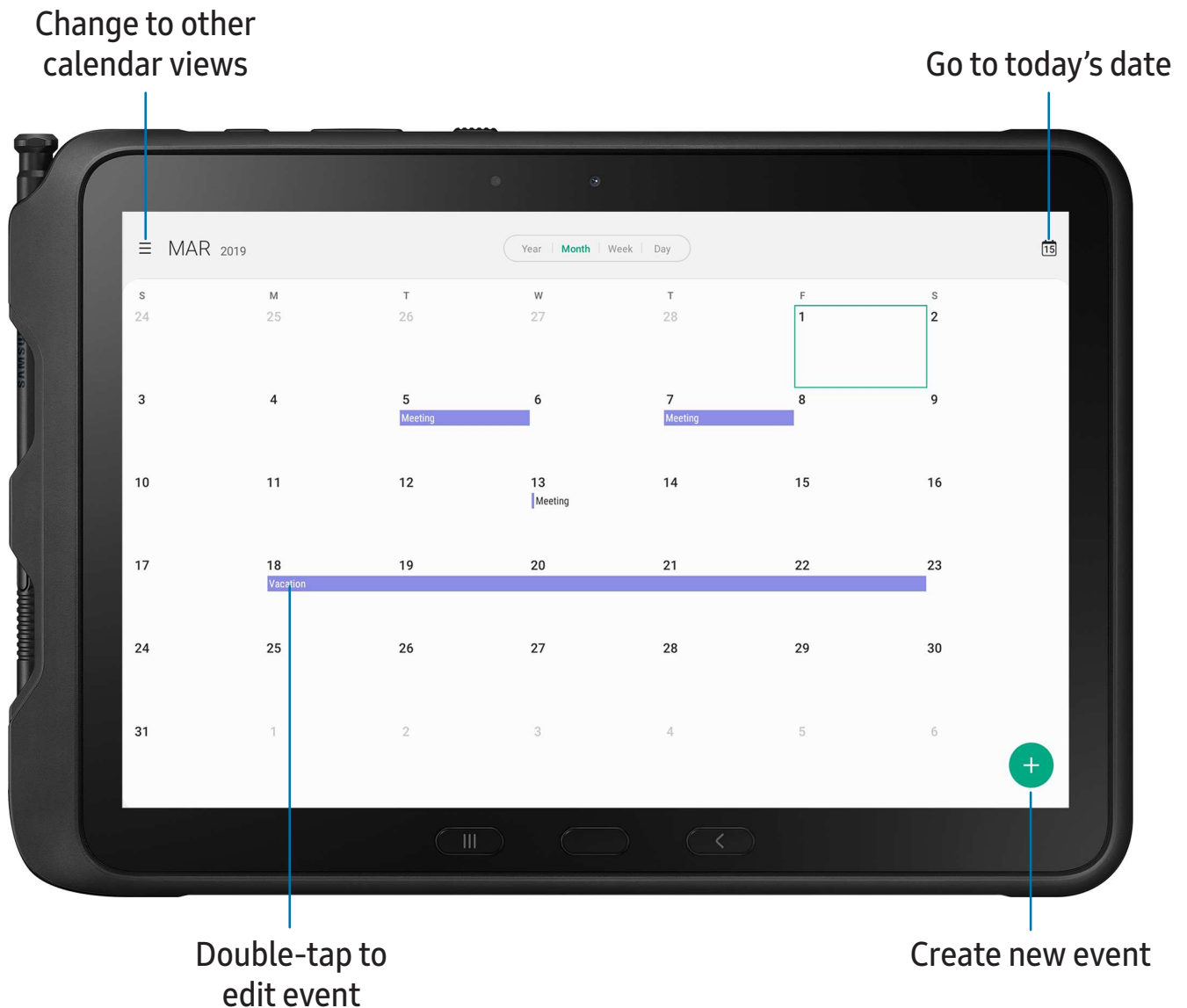

- From Apps, tap  Calendar.



Devices and software are constantly evolving — the illustrations you see here are for reference only.

## Add calendars



Add your accounts to the Calendar app.

1. From  **Calendar**, tap  **Menu**.
2. Tap  **Settings** > **Add new account** and select an account type.
3. Enter your account information and follow the prompts.

 **TIP** Accounts may also support email, contacts, and other features.

## Create an event

Use your Calendar to create events.

1. From  **Calendar**, tap  **Add event** to add an event.
2. Enter details for the event, and then tap **Save**.

## Delete an event

Delete events from your Calendar.

1. From  **Calendar**, tap an event, and tap again to edit it.
2. Tap **Delete**, and confirm when prompted.

# Camera

You can capture high-quality pictures and videos using the Camera app.

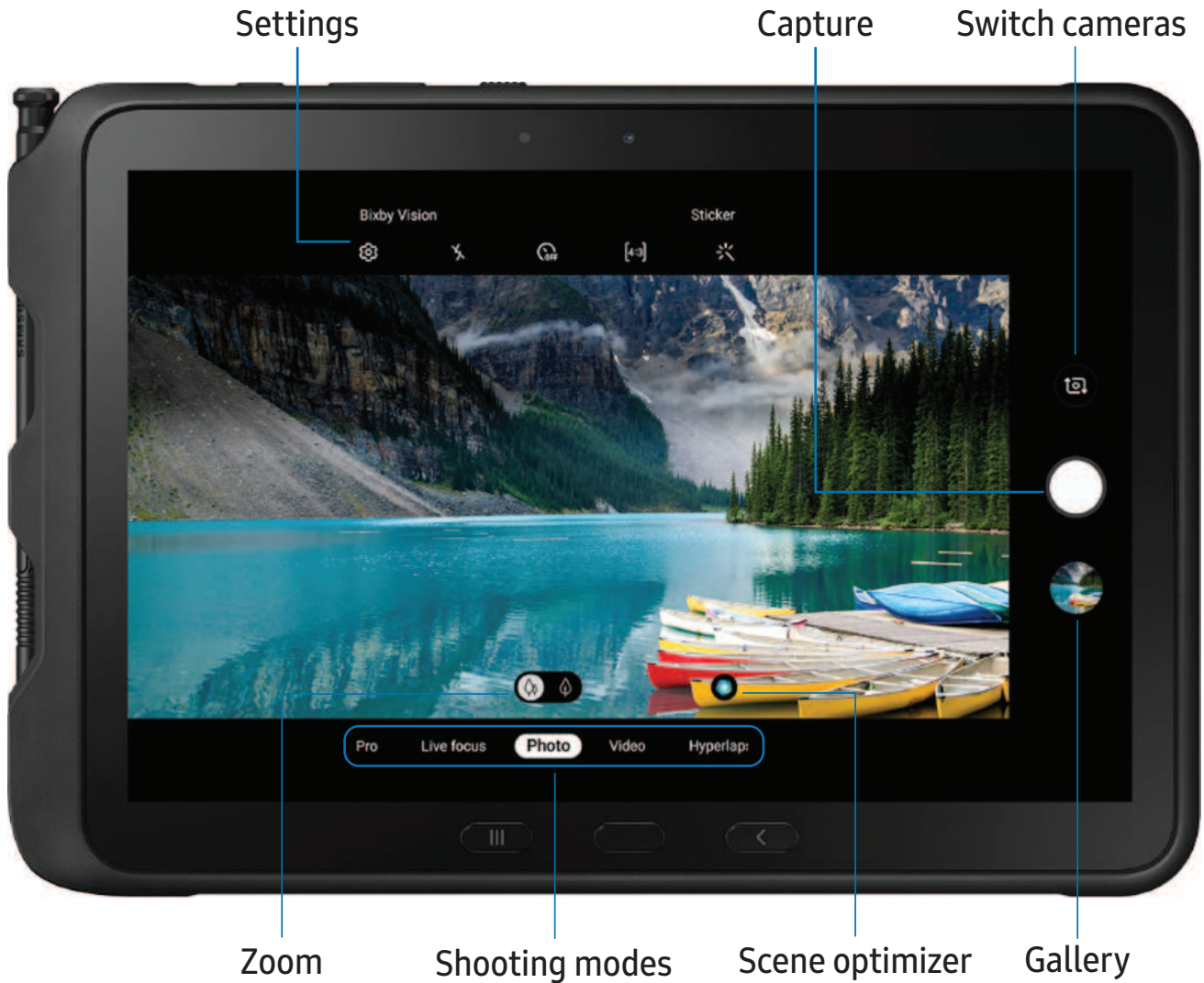

- From Apps, tap  Camera.



Devices and software are constantly evolving — the illustrations you see here are for reference only.





## Navigate the camera screen

Take stunning pictures with your device's front and rear cameras.

1. From  **Camera**, set up your shot with the following features:
  - Tap the screen where you want the camera to focus.
    - When you tap the screen, a brightness scale appears. Drag the light bulb to adjust the brightness.
  - To quickly switch between the front and rear cameras, swipe the screen up or down.
  - To change to a different shooting mode, swipe the screen right or left.
  - To change camera settings, tap  **Settings**.
2. Tap  **Capture**.

## Record videos

Record high-quality videos using your device.

1. From  **Camera**, swipe right or left to change the shooting mode to **Video**.
2. Tap  **Capture** to begin recording a video.
  - To temporarily stop recording, tap  **Pause**. To continue recording, tap  **Resume**.
3. Tap  **Stop** when you are finished recording.

## Change shooting modes

The Camera is equipped with a variety of shooting modes to capture pictures and videos in specific scenarios.

- From  **Camera**, the shooting modes are located in a row near the bottom of the screen.
  - To change the shooting mode, swipe the screen right or left.
  - To view the entire list of shooting modes and each mode's description, touch and hold a shooting mode.



## Configure shooting mode

Allow the camera to determine the ideal mode for your pictures or choose from several shooting modes.

- From  **Camera**, touch and hold a shooting mode.
  - **Food**: Take pictures that emphasize the vivid colors of food.
  - **Panorama**: Create a linear image by taking pictures in either a horizontal or vertical direction.
  - **Pro**: Manually adjust the ISO sensitivity, exposure value, white balance, and color tone while taking pictures.
  - **Live focus**: Take artistic pictures by adjusting the depth of field.
  - **Photo**: Allow the camera to determine the ideal mode for the picture.
  - **Video**: Allow the camera to determine the ideal mode for the video.
  - **Hyperlapse**: Create a time lapse video by recording at various frame rates. The frame rate is adjusted depending on the scene being recorded and the movement of the device.

## Camera settings

Use the icons on the main camera screen and the settings menu to configure your camera's settings.

- From  **Camera**, tap  **Settings** for the following options:
  - **Scene optimizer**: Automatically adjust the color settings of your pictures to match the subject matter.
  - **Scan QR codes**: Automatically detect QR codes when using the camera.

### Pictures

- **Hold shutter button to**: Choose whether to take a picture, take a burst shot, or create a GIF when holding the shutter button down.
- **HEIF pictures (Photo)**: Save pictures as high efficiency images to save space.

## Videos

- **Rear video size:** Select a resolution. Selecting a higher resolution for higher quality requires more memory.
- **Front video size:** Select a resolution. Selecting a higher resolution for higher quality requires more memory.
- **High efficiency video:** Record videos in HEVC format to save space.
- **Video stabilization:** Activate anti-shake to keep the focus steady when the camera is moving.

## Useful features

- **HDR (rich tone):** Enables the light sensitivity and color depth features of the device to produce a brighter and richer picture.
- **Pictures as previewed:** Save self-portraits or self-recordings as viewed on the camera screen, not as flipped images.
- **Grid lines:** Display viewfinder grid lines to help compose a picture or video.
- **Location tags:** Attach a GPS location tag to the picture.
- **Camera modes:** Set the default camera mode. You can also reorder or hide your shooting modes.
- **Shooting methods:**
  - **Press Volume key to:** Use the Volume key to take pictures, record video, zoom, or control system volume.
  - **Floating shutter button:** Add an extra shutter button that you can move anywhere on the screen.
  - **Show palm:** Hold your hand out with your palm facing the camera to have your picture taken in a few seconds.
- **Storage location:** Select a memory location.
  - A memory card (not included) must be installed to view Storage location.
- **Shutter sound:** Play a tone when taking a picture.
- **Reset settings:** Reset the camera settings.
- **About Camera:** View app and software information.

# 1 Clock

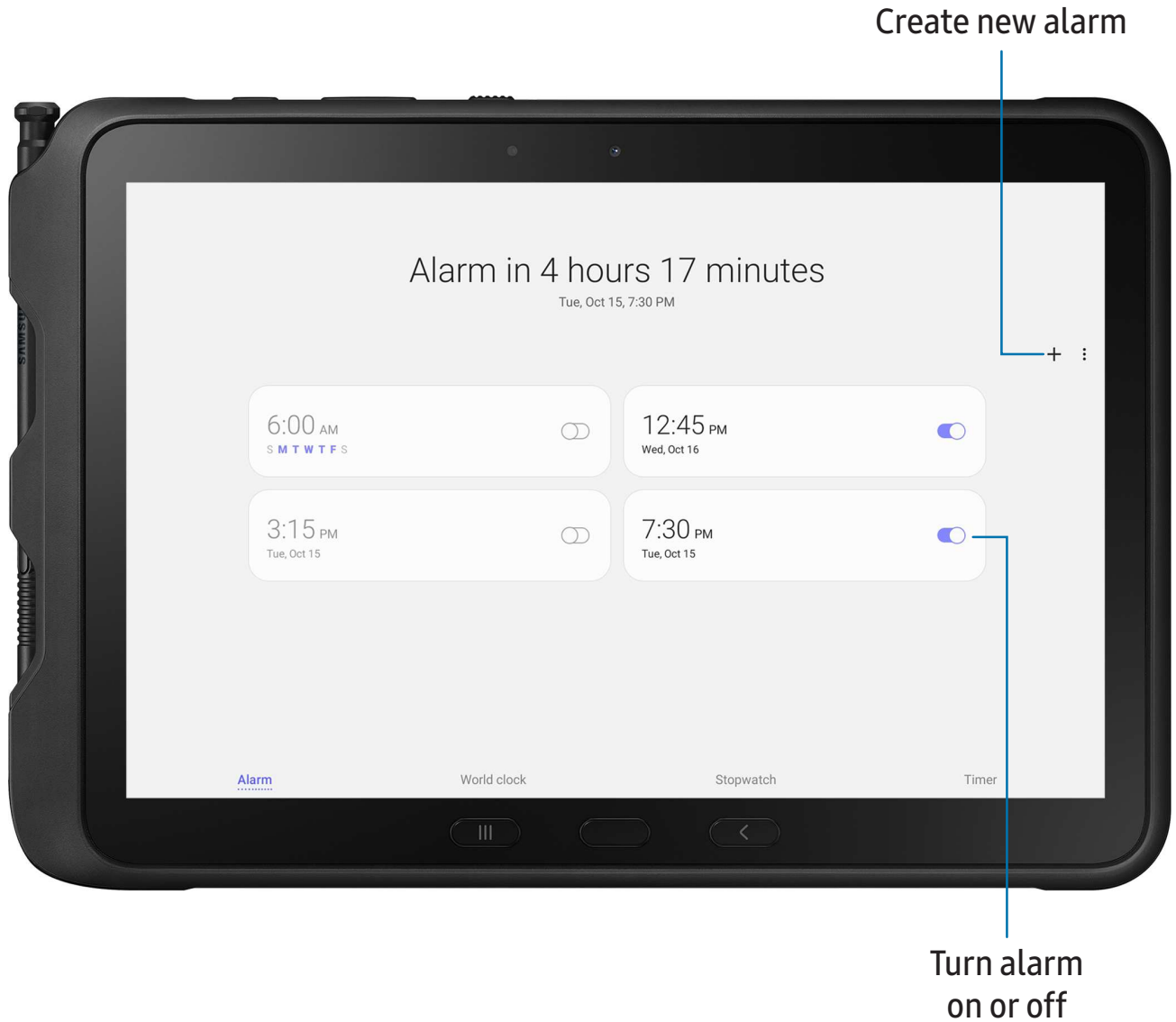

The Clock app offers features for keeping track of time and setting alarms.

- From Apps, tap **1** Clock, and tap a tab to use a feature.





## Alarm

Use the Alarm tab to set one-time or recurring alarms and choose options for how to be notified.

1. From  **Clock**, tap  **Add alarm**.
2. Tap the following items to configure an alarm:
  - **Time**: Set a time for the alarm.
  - **Day**: Choose the day for this alarm.
  - **Alarm name**: Enter a name for the alarm.
  - **Alarm sound**: Choose a sound to play for the alarm and drag the slider to set the volume of the alarm.
  - **Vibration**: Choose whether the alarm uses vibration alert.
  - **Snooze**: Allow snoozing. Set interval and repeat values for the alarm while snoozing.
3. Tap **Save** to save the alarm.

### Delete an alarm

You can delete an alarm that you created.

1. From  **Clock**, touch and hold an alarm.
2. Tap  **Delete**.



## World clock

The World clock lets you keep track of the current time in multiple cities around the globe.

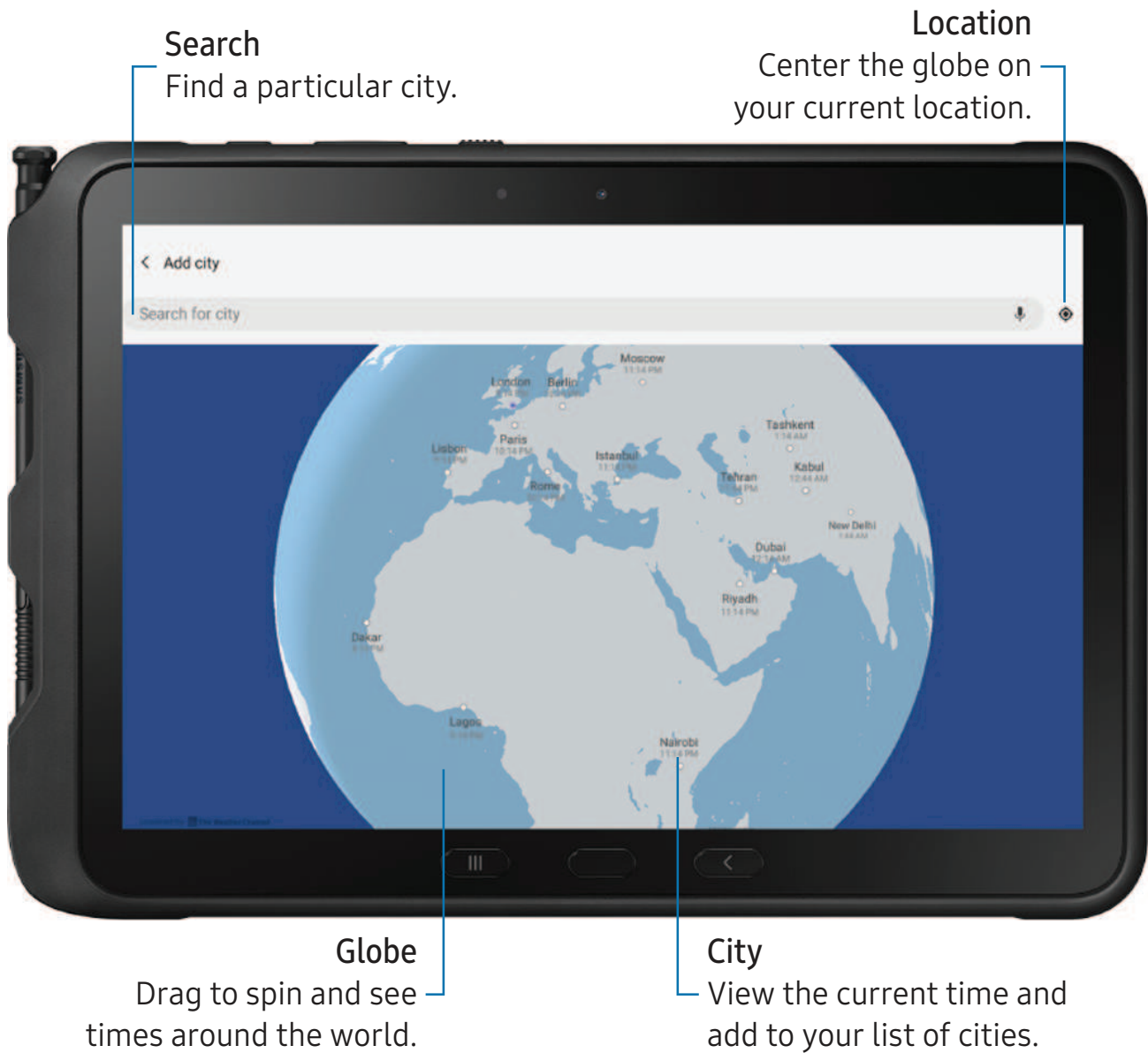





1. From **1** Clock, tap World clock.
2. Tap **+** Add city > Search for city, and enter the name of the city.

3. Tap the city name in the list, and then tap **Add**.
  - To remove a city, touch and hold it, and tap  **Delete**.



## Time zone converter

Set a time in a city on your World clock list to see what the local times would be in the other listed cities.

1. From  **Clock**, tap **World clock**.
2. Tap  **More options** > **Time zone converter**.
3. Tap  **Menu** to choose a different city.
  - To add a city to the list, tap  **Add city**.
4. Swipe the hours, minutes, and period (**AM** or **PM**) on the clock to set a time. Local times for the other cities listed are automatically updated.
  - To return the clock to the current time, tap **Reset**.

## Weather settings

Show weather information on your World clock.

1. From  **Clock**, tap **World clock**.
2. Tap  **More options** > **Weather settings**.
3. Tap  to enable.
4. Tap **Unit** to change from Fahrenheit to Celsius.

## Stopwatch

The Stopwatch lets you time events down to a hundredth of a second.

1. From  **Clock**, tap **Stopwatch**.
2. Tap **Start** to begin timing.
  - To keep track of lap times, tap **Lap**.
3. Tap **Stop** to end timing.
  - To continue timing after stopping the clock, tap **Resume**.
  - To reset the Stopwatch to zero, tap **Reset**.



## Timer

Set a countdown timer for up to 99 hours, 59 minutes, and 59 seconds.

1. From  **Clock**, tap **Timer**.
2. Use the keypad and tap **Hours**, **Minutes**, and **Seconds** to set the Timer.
3. Tap **Start** to begin the Timer.
  - To temporarily stop the Timer, tap **Pause**. To continue, tap **Resume**.
  - To stop and reset the Timer, tap **Cancel**.

### Timer options

You can customize the Timer options.

- From  **Clock**, tap **Timer** and choose an option:
  -  **Add preset timer**: Save a preset timer with a custom name.
  -  **More options**:
    - **Set timer sound**: Choose the timer sound or create your own.

## Contacts

Store and manage your contacts. You can synchronize with personal accounts added to your device. Accounts may also support email, calendars, and other features.

○ From Apps, tap  **Contacts** >  **Create contact**.

 **NOTE** Some features are only available when Call & text on other devices is enabled.

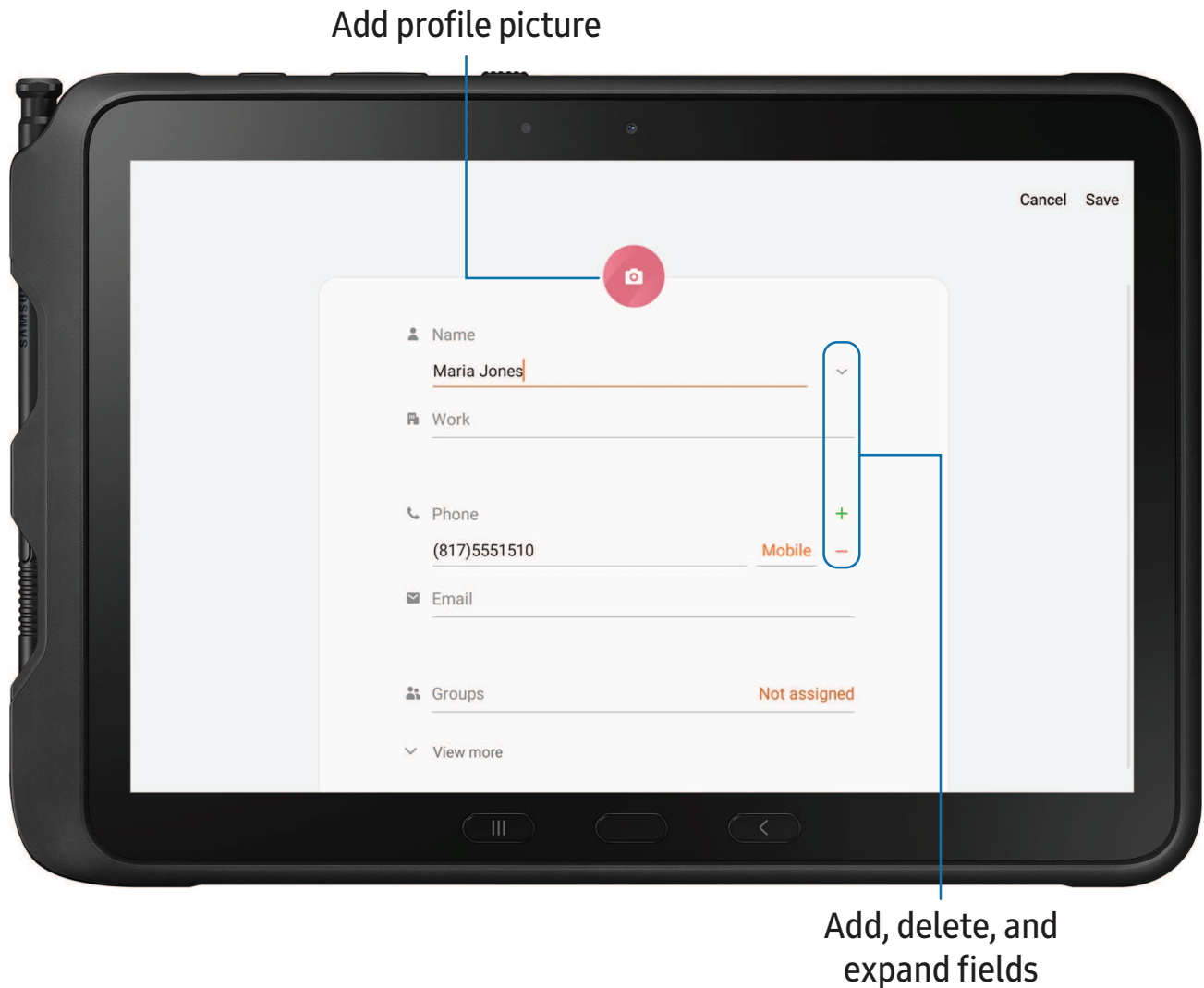



## Edit a contact

When editing a contact, you can tap a field and change or delete information, or you can add more fields to the contact's list of information.

1. From  **Contacts**, tap a contact.
2. Tap **Edit**.
3. Tap any of the fields to add, change, or delete information.
4. Tap **Save**.



## Call or message a contact

You can quickly call or message a contact using their default phone number.

1. From  **Contacts**, tap a contact.
2. Tap  **Call** or  **Message**.



## Direct share

Share content directly with your contacts from within any app. Once enabled, your frequent contacts are displayed in the Share window.

- From Settings, tap  **Advanced features** > **Direct share**, and tap  to enable the feature.

## Favorites

When you mark contacts as favorites, they are easily accessible from other apps.

1. From  **Contacts**, tap a contact.
2. Tap  **Add to Favorites** to mark the contact as a favorite.
  - To remove the contact from Favorites, tap  **Favorite**.

## Share a contact

Share a contact with others by using various sharing methods and services.

1. From  **Contacts**, tap a contact.
2. Tap **Share**.

3. Tap either **vCard file (VCF)** or **Text**.
4. Choose a sharing method and follow the prompts.



 **TIP** When viewing a contact, tap **QR code** to quickly share the information with friends or family. The QR code automatically updates when you change the contact information.

## Groups

You can use groups to organize your contacts.





### Create a group

Create your own contact groups.

1. From  **Contacts**, tap  **Menu** > **Groups**.
2. Tap **Create group**, and then tap fields to enter information about the group:
  - **Group name:** Enter a name for the new group.
  - **Group ringtone:** Customize the sounds for the group.
  - **Add member:** Select contacts to add to the new group, and then tap **Done**.
3. Tap **Save**.



### Add or remove group contacts

Add more contacts to a group, or remove contacts.

- From  **Contacts**, tap  **Menu** > **Groups**, and then tap a group.
  - To remove a contact, touch and hold a contact to select it, and then tap  **Delete**.
  - To add a contact, tap  **More options** > **Edit group** > **Add member**, and then tap the contacts you want to add. When finished, tap **Done** > **Save**.



### Send a message to a group

Send a text message to members of a group.

1. From  **Contacts**, tap  **Menu** > **Groups**, and then tap a group.
2. Tap  **More options** > **Send message**.



## Send an email to a group

Send an email to members of a group.

1. From  **Contacts**, tap  **Menu** > **Groups**, and then tap a group.
2. Tap  **More options** > **Send email**.
3. Tap contacts to select them, or tap the **All** checkbox at the top of the screen to select all, and then tap **Done**.
  - Only group members that have an email address in their records are displayed.
4. Choose an email account and follow the prompts.

## Delete a group

Delete a group you have created.



1. From  **Contacts**, tap  **Menu** > **Groups**, and then tap a group.
2. Tap  **More options** > **Delete group**.
  - To only delete the group, tap **Group only**.
  - To delete the group and the contacts in the group, tap **Group and members**.

## Manage contacts

You can import or export contacts, as well as link multiple contacts into one contact entry.



### Import contacts

Import contacts to your device as vCard files (VCF).

1. From  **Contacts**, tap  **Menu** > **Manage contacts**.
2. Tap **Import/export contacts**.
3. Tap **Import** and follow the prompts.



## Export contacts

Export contacts from your device as vCard files (VCF).



1. From  **Contacts** tap  **Menu** > **Manage contacts**.
2. Tap **Import/export contacts**.
3. Tap **Export** and follow the prompts.

## Link contacts

Consolidate contact information from multiple sources into one contact by linking entries into a single contact.



1. From  **Contacts**, tap the contact to select it.
2. Tap  **More options** > **Link to another contact**.
3. Tap contacts to choose them.
4. Tap **Link**.

To unlink contacts:

1. From  **Contacts**, tap the contact to select it.
2. Tap  **More options** > **Add/remove linked contacts**.
3. Tap **Unlink** beside contacts to unlink them from the main contact.

## Delete contacts

Delete a single contact or multiple contacts.

1. From  **Contacts**, touch and hold a contact to select it.
  - You can also tap other contacts to select them for deletion.
2. Tap  **Delete**, and confirm when prompted.



# Gallery

Go to the Gallery to look at the all the visual media stored on your device. You can view, edit, and manage pictures and videos.

- From Apps, tap  Gallery.

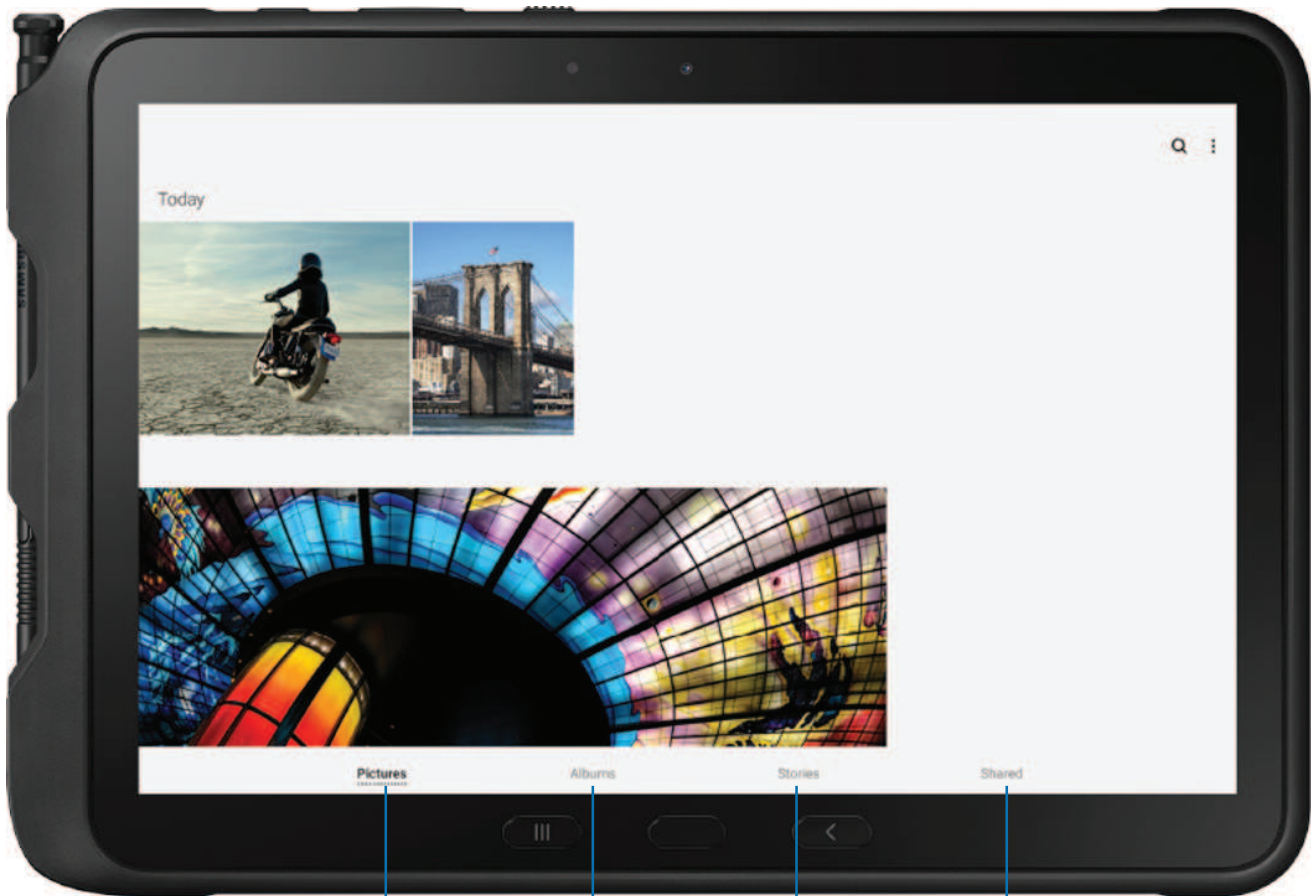

Sort images into custom albums



View pictures and videos

Customize collections of pictures and videos

Share pictures and videos









## View pictures

Pictures stored on your device are viewable in the Gallery app.

1. From  **Gallery**, tap **Pictures**.
2. Tap a picture to view it. Swipe left or right to view other pictures or videos.
  - To mark the picture as a favorite, tap  **Favorite**.
  - To access the following features, tap  **More options**:
    - **Details**: View and edit information about the picture.
    - **Set as wallpaper**: Set the picture as wallpaper.
    - **Send as live message**: Use Live message to draw an animation on a picture and share it.
    - **Move to Secure Folder**: Move the picture to a Secure Folder.
    - **Print**: Send the picture to a connected printer.





## Edit pictures

Enhance your pictures using the Gallery's editing tools.

1. From  **Gallery**, tap **Pictures**.
2. Tap a picture to view it, and then tap  **Edit** for the following options:
  -  **Transform**: Rotate, flip, crop, or make other changes to the overall appearance of the picture.
  -  **Filters**: Add color effects.
  -  **Sticker**: Overlay illustrated or animated stickers.
  -  **Text**: Add text to the picture.
  -  **Draw**: Add handwritten text or hand drawn content.
  -  **Tone**: Adjust brightness image controls.



## Play video

View the videos stored on your device. You can save videos as favorites, and view video details.

1. From  **Gallery**, tap **Pictures**.
2. Tap a video to view it. Swipe left or right to view other pictures or videos.
  - To mark the video as a favorite, tap  **Favorite**. The video is added to Favorites under the Albums tab.
  - To access the following features, tap  **More options**:
    - **Details**: View and edit information about the video.
    - **Move to Secure Folder**: Add this video to your Secure Folder.
3. Tap  **Play video** to play the video.



## Edit video

Edit videos stored on your device.

1. From  **Gallery**, tap **Pictures**.
2. Tap a video to view it.
3. Tap  **Edit** to cut segments of the video.
4. Tap **Save**, and then confirm when prompted.



## Share pictures and videos

Share pictures and videos from the Gallery app.

1. From  **Gallery**, tap **Pictures**.
2. Tap  **More options** > **Share**, and then tap pictures and videos to select them.
3. Tap  **Share**, and then choose an app or connection to use for sharing your selection. Follow the prompts.

## Delete pictures and videos

Delete pictures and videos stored on your device.

1. From  **Gallery**, tap  **More options** > **Edit**.
2. Tap pictures and videos to select them, or tap the **All** checkbox at the top of the screen to select all pictures and videos.
3. Tap  **Delete**, and confirm when prompted.





## Take a screenshot

Capture an image of your screen. Your device will automatically create a Screenshots album in the Gallery app.

- From any screen, press and hold the **Side** and **Volume down** keys.

## Screen recorder

Record activities on your device, write notes, and use the camera to record a video overlay of yourself to share with friends or family.

1. From Quick Settings, tap  **Screen recorder** to begin recording.
  - Tap  **Draw** to draw on the screen.
  - Tap  **Selfie video** to include a recording from your front camera.
2. Tap  **Stop** to finish recording. These are automatically saved to the Screen recording album in the Gallery.

## Screen recorder settings

Control the sound and quality settings for the screen recorder.

- From Settings, tap  **Advanced features** > **Screenshots and screen recorder** > **Screen recorder settings**.
  - **Sound:** Choose what sounds to record while using the screen recorder.
  - **Video quality:** Select a resolution. Selecting a higher resolution for higher quality requires more memory.
  - **Selfie video size:** Drag the slider to set the size of the video overlay.

## Internet

Samsung Internet is a simple, fast, and reliable web browser for your device. Experience more secure Web browsing features with Secret Mode, Biometric Web Login, and Contents Blocker.

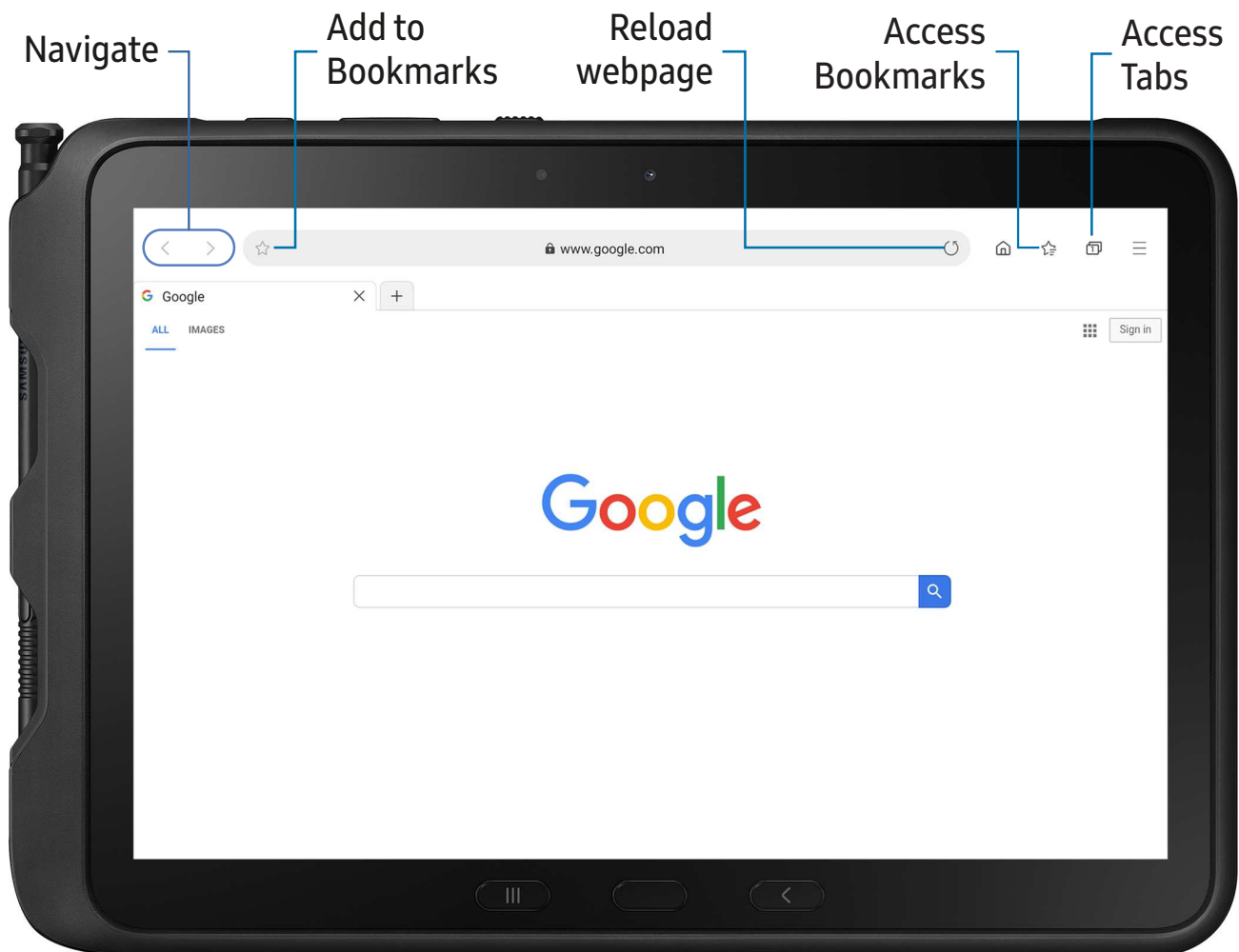

- From Apps, tap **Samsung folder** >  **Internet**.



 **TIP** Visit [samsung.com/us/support/owners/app/samsung-internet](https://samsung.com/us/support/owners/app/samsung-internet) for more information.

## Browser tabs

Use tabs to view multiple web pages at the same time.



- From  **Internet**, tap **New tab**.
  - To close a tab, tap  **Close tab**.

## Bookmarks

The Bookmarks page stores Bookmarks, Saved pages, and your browsing History.



### Open a Bookmark



Quickly launch a web page from the Bookmarks page.

1. From  **Internet**, tap  **Bookmarks**.
2. Tap a bookmark entry.

### Save a web page

Saving a web page stores its content on your device so that you can access it offline.

- From  **Internet**, tap  > **Add page to** > **Saved pages**.

 **NOTE** To view saved web pages, tap  > **Saved pages**.

### View history



To view a list of recently visited web pages:

- From  **Internet**, tap  > **History**.

 **TIP** To clear your browsing history, tap  **More options** > **Clear history**.

## Share pages



Web pages can be shared with your contacts.

- From  **Internet**, tap  > **Share**, and follow the prompts.

## Secret mode

Pages viewed in Secret mode are not listed in your browser history or search history, and leave no traces (such as cookies) on your device. Secret tabs are a darker shade than the normal tab windows.

Any downloaded files remain on your device after you close the secret tab.

1. From  Internet, tap  > Turn on Secret mode.
2. Tap **Set password** to protect your Secret mode data with a password.

To turn off Secret mode:

- From  Internet, tap  > Turn off Secret mode.

## Internet settings

Modify settings associated with using the Internet app.

- From  Internet, tap  > Settings.

# Messages

Keep in touch with your contacts by using the Messages app to share photos, send emojis, or just say a quick hello.

○ From Apps, tap  Messages >  Compose.

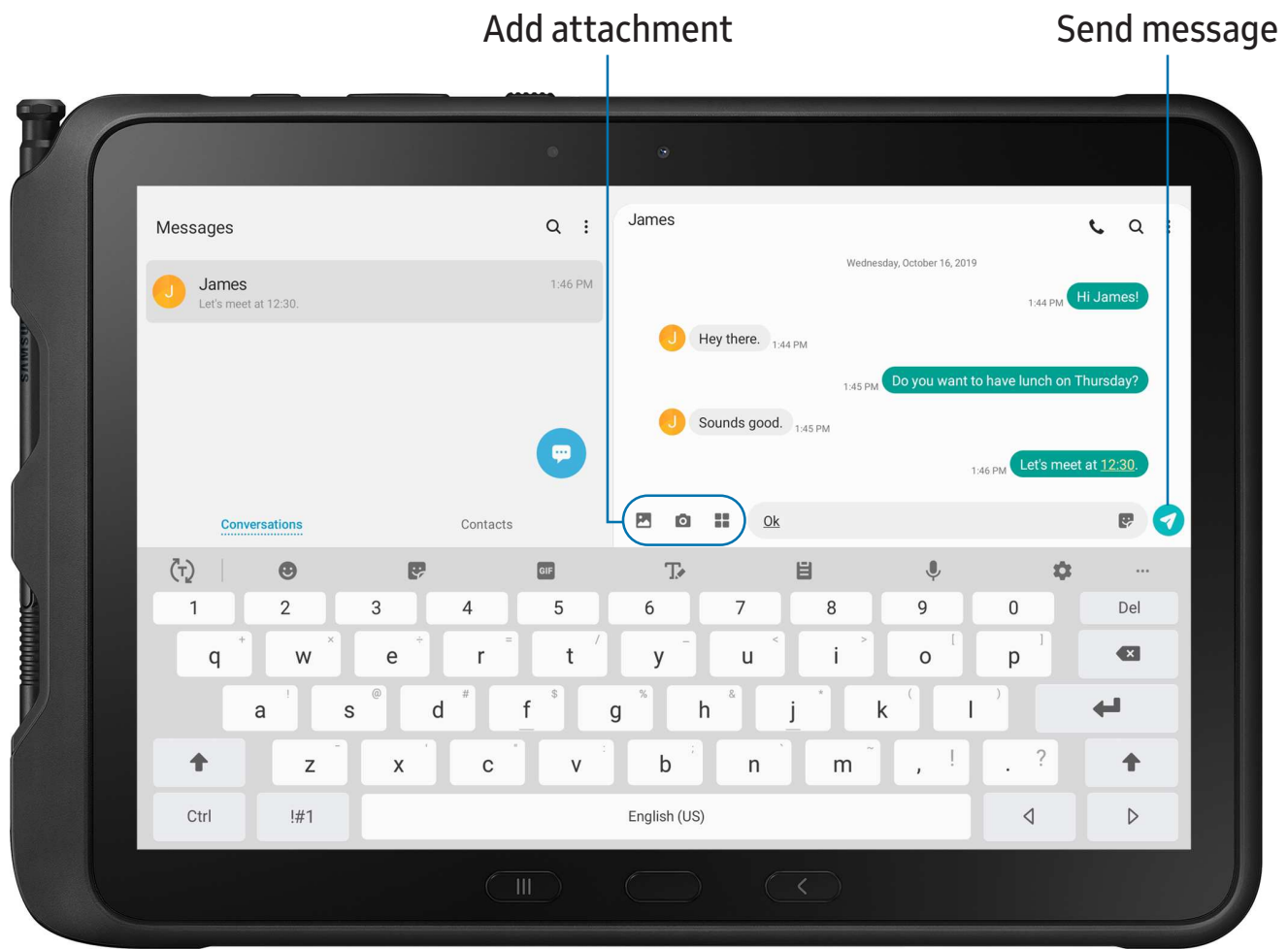

 **NOTE** This feature is only available when Call & text on other devices is enabled.







## Message search

To quickly locate a message, use the search feature.

1. From  Messages, tap  Search.
2. Enter keywords in the Search field, and then tap  Search on the keyboard.

## Delete conversations

You can remove your conversation history by deleting conversations.

1. From  Messages, tap  More options > Delete.
2. Tap each conversation you want to delete.
3. Tap  Delete, and confirm when prompted.

## Message settings

Configure the settings for text and multimedia messages.

- From  Messages, tap  More options > Settings.

# My Files

View and manage files stored on your device, including images, videos, music, and sound clips.

- From Apps, tap **Samsung** folder > **My Files**.

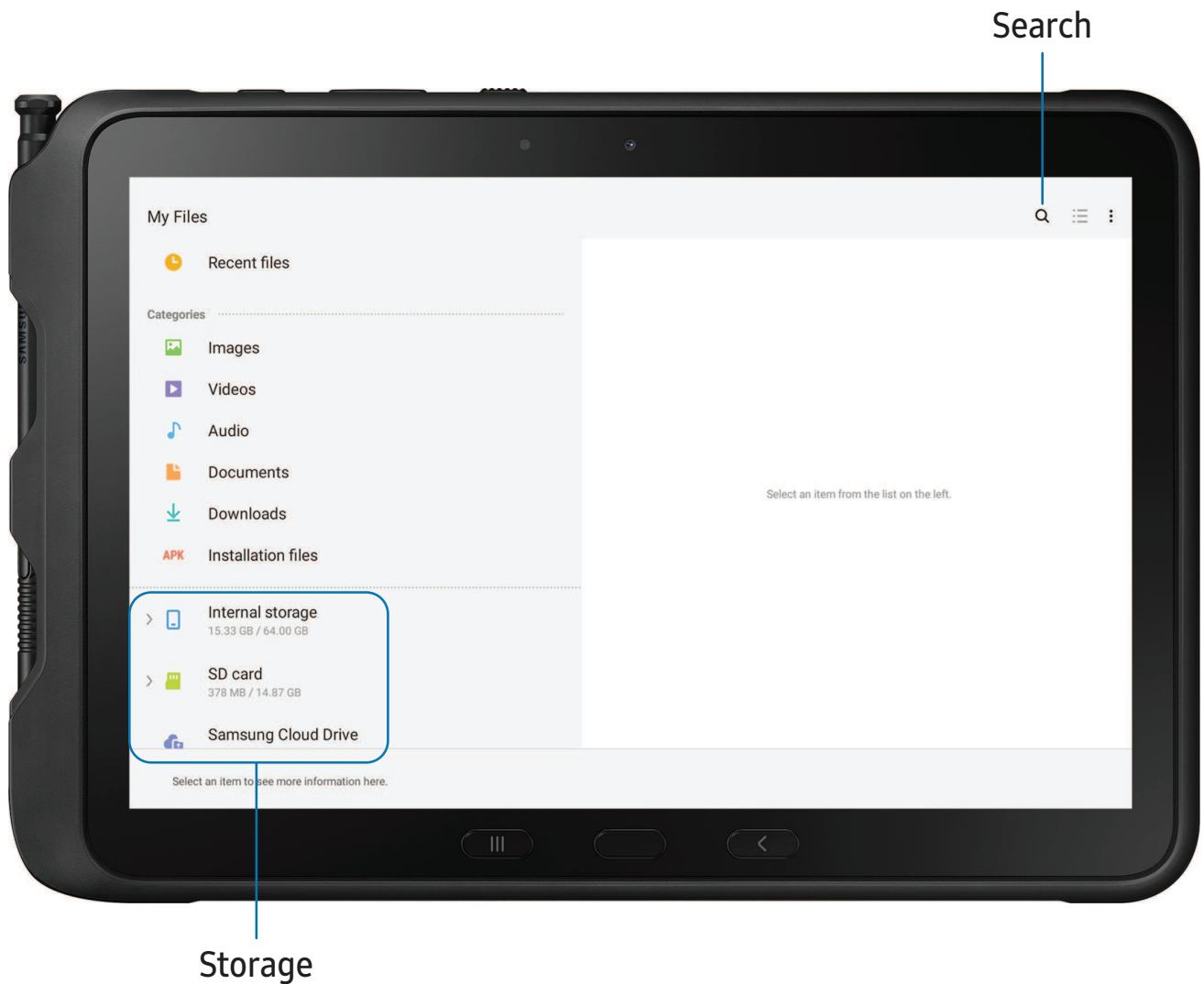

Devices and software are constantly evolving — the illustrations you see here are for reference only.



## File groups

Files stored in the device are organized into the following groups:

- **Recent files:** View recently accessed files.
- **Categories:** View your files based on the file type.
- **Storage:** View files saved on your device, optional SD card, and cloud accounts.
  - Cloud drives vary depending on the services you sign in to.
- **Storage analysis:** See what's taking up space in your storage.

## My Files options

Use My Files options to search, edit, clear file history, and more.

- From  **My Files**, the following options are available:
  -  **Search:** Search for a file or folder.
  -  **More options:**
    - **Storage analysis:** See what's taking up space in your storage.
    - **Settings:** View settings for the app.

## Phone

The Phone app does more than just make telephone calls. Explore the advanced calling features. See your carrier for more information.

- From a Home screen, tap  Phone.

 **NOTE** This feature is only available when Call & text on other devices is enabled.

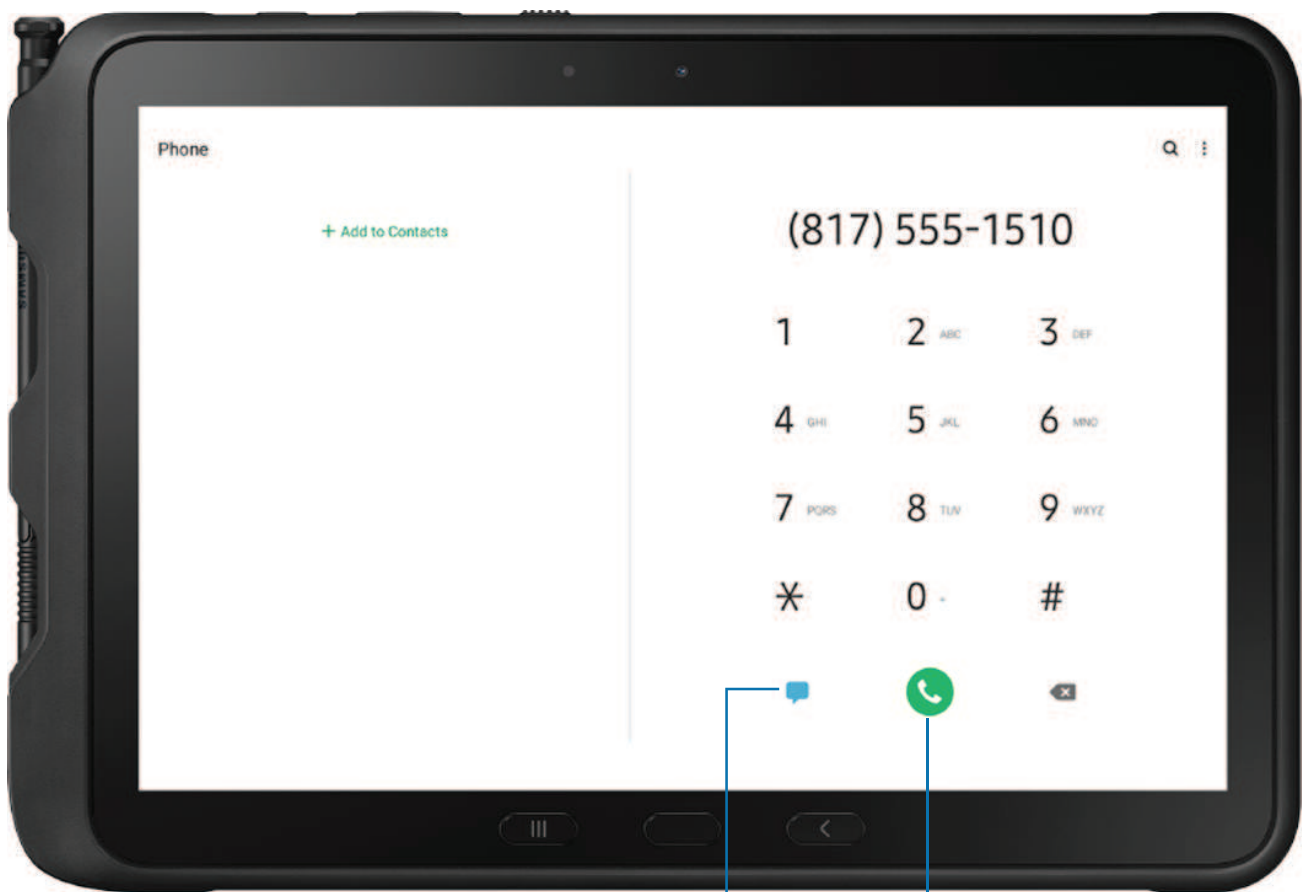

Access  
Messages



Make a call

## Calls

The Phone app allows you to make and answer calls from the Home screen, Recents tab, Contacts and more.



### Make a call

Use your phone to make and answer calls from a Home screen.

- From  **Phone**, enter a number on the keypad and tap  **Call**.
  - Tap **Keypad** if the keypad is not displayed.

Make a call from Recents

All incoming, outgoing, and missed calls are recorded in the Call log.

1. From  **Phone**, tap **Recents** to display a list of recent calls.
2. Tap a contact, and then tap  **Call**.

### Answer a call

When a call is received, the phone rings and the caller's phone number or name is displayed. If you are using an app, a pop-up screen is displayed for the incoming call.



- On the incoming call screen, drag  **Answer** to the right to answer the call.

 **TIP** On the incoming call pop-up screen, tap  **Answer** to answer the call.

### Decline a call

You can choose to decline an incoming call. If you are using an app, a pop-up screen is displayed for the incoming call.

- On the incoming call screen, drag  **Decline** to the left to reject the call and send it to your voicemail.

 **TIP** On the incoming pop-up screen, tap  **Decline** to reject the call and send it to your voicemail.

### End a call

- Tap  **End** when you are ready to end your call.

## Actions while on a call

You can adjust call volume, switch to a headset or speaker, and even multitask while on a call.

- Press the **Volume** keys to increase or decrease the volume.

## Switch to headset

Listen to the call using a Bluetooth headset (not included).

- Tap  **Bluetooth** to hear the caller using a Bluetooth headset.

## Multitask

If you exit the call screen to use another app, your active call is indicated in the Status bar.

To return to the call screen:

- Drag the Status bar down to display the Notification panel and tap the call.

To end a call while multitasking:

- Drag the Status bar down to display the Notification panel, and then tap  **End call**.

## Places

Explore nearby business and venues to get contact information and directions. Location services must be enabled to use this feature.

1. From  **Phone**, tap **Places**.
2. Tap a category to search nearby.
3. Tap a location to view contact information and directions.

## Manage calls

Your calls are recorded in a call log. You can set up speed dials, block numbers, and use voicemail.



### Call log

The numbers of the calls you have dialed, received, or missed are stored in the Call log.

- From  Phone, tap **Recents**. A list of recent calls is displayed. If the caller is in your Contacts list, the caller's name is displayed.



### Save a contact from a recent call

Use recent call information to create a contact or update your Contacts list.

1. From  Phone, tap **Recents**.
2. Tap the call that contains the information that you want to save to your Contacts list, and tap  **Add**.
3. Tap **Create contact** or **Update existing**.

### Delete call records

To delete Call log entries:

1. From  Phone, tap **Recents**.
2. Touch and hold the call you want to delete from the Call log.
3. Tap  **Delete**.

## Phone settings

These settings allow you to modify settings associated with the Phone app.



- From  Phone, tap  **More options** > **Settings**.

## Optional calling services

If available with your service plan, the following calling services are supported.

### Place a multi-party call

If your service plan supports this feature, you can make another call while a call is in progress.

1. From the active call, tap  **Add call** to dial the second call.
2. Dial the new number and tap  **Call**. When the call is answered:
  - Tap the **On hold** number to switch between the two calls.
  - Tap  **Merge** to hear both callers at once (multi-conferencing).



# Google apps

Enjoy these apps from Google.



## Chrome

Browse the Internet with Chrome™ and bring your open tabs, bookmarks, and address bar data from your computer to your mobile device.

Visit [support.google.com/chrome](https://support.google.com/chrome) to learn more.



## Drive

Open, view, rename, and share files saved to your Google Drive™ cloud account.

Visit [support.google.com/drive](https://support.google.com/drive) to learn more.



## Duo

Make one-to-one video calls.

Visit [support.google.com/duo](https://support.google.com/duo) to learn more.



## Gmail

Send and receive email with Google's web-based email service.

Visit [support.google.com/mail](https://support.google.com/mail) to learn more.



## Google

Find online content with tools that learn what interests you. Turn on your personalized feed to receive customized content.

Visit [support.google.com/websearch](https://support.google.com/websearch) to learn more.



## Maps

Get directions and other location-based information. You must enable location services to use Google Maps. For more information, see **Location** on page 122.

Visit [support.google.com/maps](https://support.google.com/maps) to learn more.



## Photos

Store and back up your photos and videos automatically to your Google Account with Google Photos™.

Visit [support.google.com/photos](https://support.google.com/photos) to learn more.



## Play Movies & TV

Watch movies and TV shows purchased from Google Play. You can also view videos saved on your device.

Visit [play.google.com/store/movies](https://play.google.com/store/movies) to learn more.



## Play Music

Play music and audio files on your device.

Visit [support.google.com/music](https://support.google.com/music) to learn more.



## Play Store

Find new apps, movies and TV shows, music, books, magazines, and games in the Google Play store.

Visit [support.google.com/play](https://support.google.com/play) to learn more.



## YouTube

Watch and upload YouTube™ videos right from your device.

Visit [support.google.com/youtube](https://support.google.com/youtube) to learn more.

# Microsoft apps

Enjoy these apps from Microsoft.



Access email, calendar, contacts, tasks, and more in Outlook. See [Add an Outlook account](#) on page 14.

Visit [support.office.com/en-us/outlook](https://support.office.com/en-us/outlook) to learn more.

- From Apps, tap **Microsoft Apps** folder >  **Outlook**.

Send message

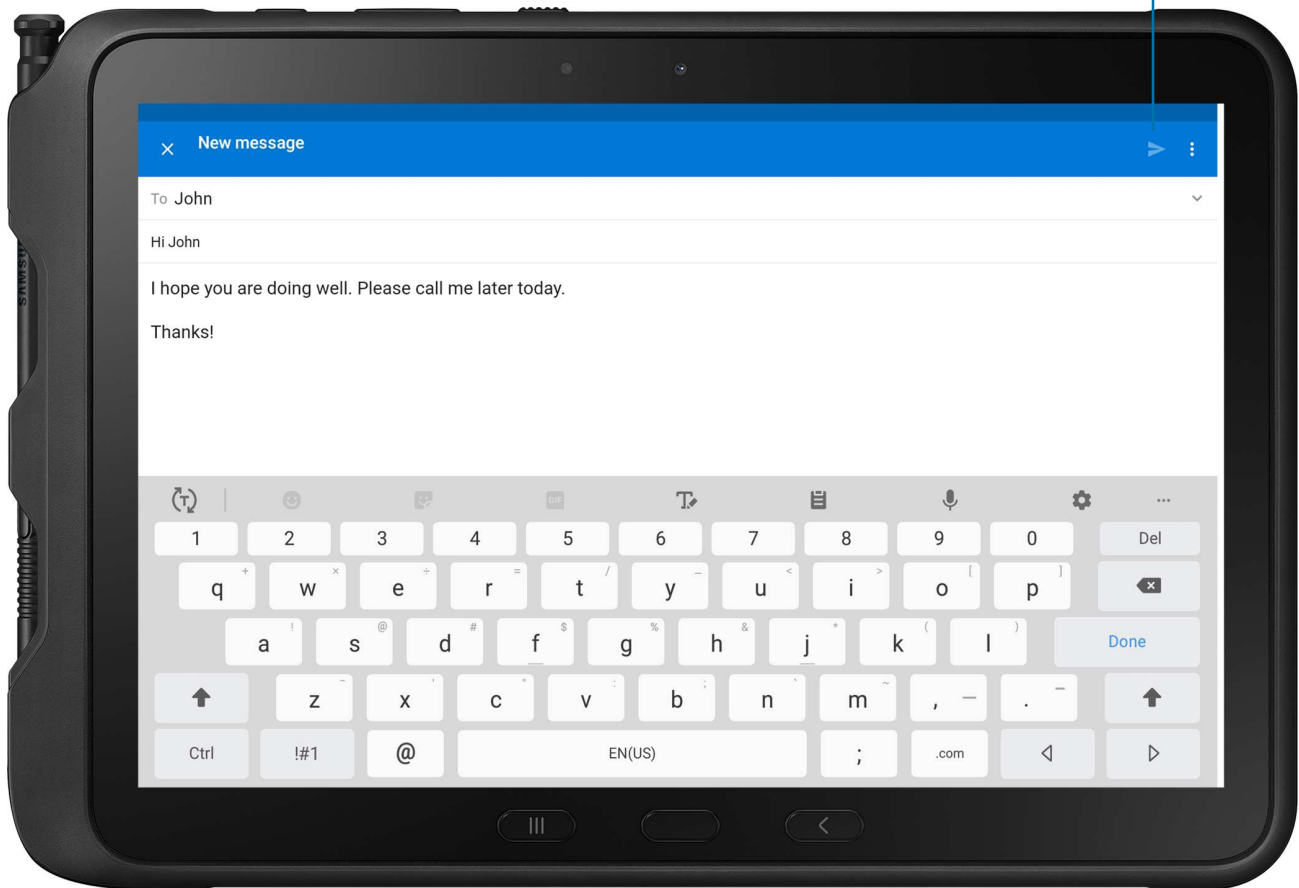



## Office Mobile

Create, view, edit, and share documents on the go.



## OneDrive

Store and share photos, videos, documents, and more in your free online OneDrive® account—accessible from your personal computer, tablet, or phone.

## Additional apps

The following apps are preloaded or downloaded over-the-air to your device.



### Spotify

Access music and podcasts on your device. You can listen to artists and albums, and create your own playlist of your favorite songs.

# Settings

---

Access Settings

Connections

Sounds and vibration

Notifications

Display

Device maintenance

Lock screen and security

Accounts

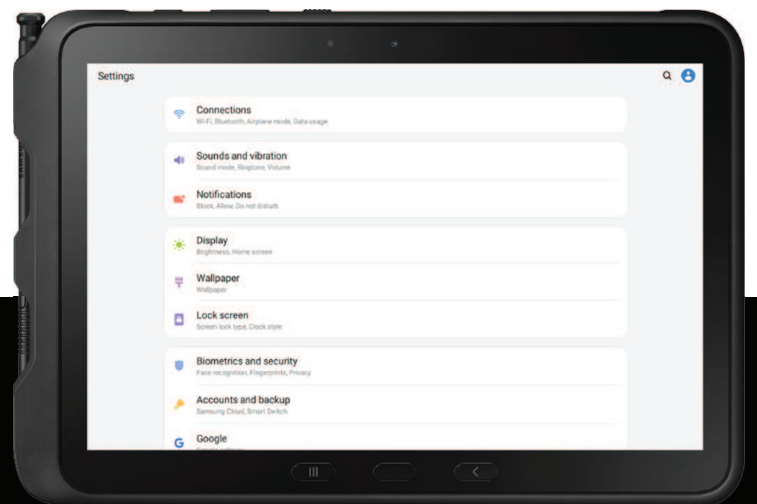

Accessibility

Other settings



## Access Settings

There are a couple of ways to access your device settings.

- Drag down the Status bar, and then tap  **Settings**.
- From Apps, tap  **Settings**.

## Search for Settings

If you are not sure exactly where to find a certain setting, you can search for it.



1. From Settings, tap  **Search**, and enter keywords.
2. Tap an entry to go to that setting.

## Connections

Manage connections between your device and a variety of networks and other devices.

### Wi-Fi



You can connect your device to a Wi-Fi network to access the Internet without using your mobile data.

1. From Settings, tap  **Connections** > **Wi-Fi**, and then tap  to turn on Wi-Fi and scan for available networks.
2. Tap a network, and enter a password if required.

### Manually connect to a Wi-Fi network

If the Wi-Fi network you want is not listed after a scan, you can still connect to it by entering the information manually.

Ask the Wi-Fi network administrator for the name and password before you begin.

1. From Settings, tap  **Connections** > **Wi-Fi**, and then tap  to turn on Wi-Fi.
2. Tap  **Add network** at the bottom of the list.



3. Enter information about the Wi-Fi network:

- **Network name:** Type the exact name of the network.
- **Security:** Select a security option from the list, and enter the password if required.
- **Auto reconnect:** Choose this option if you want to automatically reconnect to this network whenever you are in range.
- **Advanced:** Add any advanced options, such as IP and Proxy settings.

4. Tap **Save**.

## Advanced Wi-Fi settings

You can configure connections to various types of Wi-Fi networks and hotspots, manage saved networks and look up your device's network addresses.



1. From Settings, tap  **Connections** > **Wi-Fi**, and then tap  to turn on Wi-Fi.
2. Tap **Advanced**.
  - **Switch to mobile data:** When enabled, your device will switch to mobile data whenever the Wi-Fi connection is unstable. When the Wi-Fi signal is strong, it switches back to Wi-Fi.
  - **Turn on Wi-Fi automatically:** Turn on Wi-Fi in frequently-used locations.
  - **Secure Wi-Fi:** Get extra privacy protection while using unsecured Wi-Fi networks.
  - **Network notification:** Receive notifications when open networks in range are detected.
  - **Manage networks:** View saved Wi-Fi networks and configure whether to auto reconnect to or forget individual networks.
  - **Wi-Fi control history:** View apps that have recently turned your Wi-Fi on or off.
  - **Hotspot 2.0:** Connect automatically to Wi-Fi networks that support Hotspot 2.0.
  - **Install network certificates:** Install authentication certificates.



- **MAC address:** View your device's MAC address, which is required when connecting to some secured networks (not configurable).
- **IP address:** View your device's IP address (not configurable).

## Wi-Fi Direct

Wi-Fi Direct uses Wi-Fi to share data between devices.

1. From Settings, tap  **Connections** > **Wi-Fi**, and then tap  to turn on Wi-Fi.
2. Tap **Wi-Fi Direct**.
3. Tap a device, and then follow the prompts to connect.

 **TIP** When sharing a file, tap  **Wi-Fi Direct** to use this feature.



## Disconnect from Wi-Fi Direct

Disconnect your device from a Wi-Fi Direct device.

- From Settings, tap  **Connections** > **Wi-Fi** > **Wi-Fi Direct**. Tap a device to disconnect it.

## Bluetooth



You can pair your device to other Bluetooth-enabled devices, like Bluetooth® headphones or a Bluetooth-enabled vehicle infotainment system. Once a pairing is created, the devices remember each other and can exchange information without having to enter the passkey again.

1. From Settings, tap  **Connections** > **Bluetooth**, and then tap  to turn on Bluetooth.
2. Tap a device and follow the prompts to connect.

 **TIP** When sharing a file, tap  **Bluetooth** to use this feature.



## Rename a paired device

You can rename a paired device to make it easier to recognize.

1. From Settings, tap  **Connections** > **Bluetooth**, and then tap  to turn on Bluetooth.
2. Tap  **Settings** next to the device name, and then tap **Rename**.
3. Enter a new name, and tap **Rename**.

## Unpair from a Bluetooth device

When you unpair from a Bluetooth device, the two devices no longer recognize each other.

1. From Settings, tap  **Connections** > **Bluetooth**, and then tap  to turn on Bluetooth.
2. Tap  **Settings** next to the device, and then tap **Unpair**.

 **TIP** You will need to pair with the device again in order to connect to it.



## Advanced options

Additional Bluetooth features are available in the Advanced menu.

1. From Settings, tap  **Connections** > **Bluetooth**.
2. Tap **Advanced** for the following options:
  - **Media volume sync:** Sync the volume level set on the connected Bluetooth devices to your device.
  - **Bluetooth control history:** View apps that have used Bluetooth recently.



## Tablet visibility

Turn on visibility to allow other Bluetooth devices to find your device.

- From Settings, tap  **Connections** > **Tablet visibility**, and then tap  to make your device visible.

## Airplane mode

Airplane mode disconnects your device from all networks and turns off connectivity features.

1. From Settings, tap  **Connections** > **Airplane mode**.
2. Tap  to enable this feature.

## Data usage

Check your current mobile and Wi-Fi data usage. You can also customize warnings and limits.

- From Settings, tap  **Connections** > **Data usage**.



## Monitor Wi-Fi data

You can restrict Wi-Fi data access by customizing usage limits and networks.

1. From Settings, tap  **Connections** > **Data usage**.
2. Tap **Wi-Fi data usage** to view data usage over Wi-Fi connections over a period of time. You can view total usage as well as usage by app.

## Mobile hotspot

Mobile hotspot uses your data plan to create a Wi-Fi network that can be used by multiple devices.

1. From Settings, tap  **Connections** > **Mobile hotspot and tethering** > **Mobile hotspot**.
2. Tap  to turn on Mobile hotspot.
3. On the devices you want to connect, activate Wi-Fi and select your device's Mobile hotspot. Enter the Mobile hotspot password to connect.

 **TIP** Check with your carrier about service fees.



## Change the mobile hotspot password

You can customize your Mobile hotspot password to make it easier to remember.

1. From Settings, tap  **Connections** > **Mobile hotspot and tethering** > **Mobile hotspot**.
2. Tap the password, enter a new password, and then tap **Save**.



## Allowed devices list

Create a custom list of devices that are allowed to connect to your Mobile hotspot. You need the device name and MAC address of devices that you want to add to the Allowed devices list.

1. From Settings, tap  **Connections** > **Mobile hotspot and tethering** > **Mobile hotspot**.
2. Tap  **More options** > **Allowed devices**, and then tap **Add** to enter the other device's Device name and MAC address.
3. Tap **Add** to add the device.
  - To restrict connections to your Allowed devices list, tap **Allowed devices only**.



## Configure mobile hotspot settings

You can customize your mobile hotspot's security and connection settings.

1. From Settings, tap  **Connections** > **Mobile hotspot and tethering** > **Mobile hotspot**.
2. Tap  **More options** > **Configure mobile hotspot** for the following settings:
  - **Network name:** View and change the name of your Mobile hotspot.
  - **Hide my device:** Prevent your Mobile hotspot from being discoverable by other devices.
  - **Security:** Choose the security level for your Mobile hotspot.
  - **Password:** If you choose a security level that uses a password, you can view or change it.
  - **Show advanced options:** Configure additional Mobile hotspot settings.

## Timeout settings

You can set the Mobile hotspot to automatically turn off when there are no connected devices to help you manage your data usage.

1. From Settings, tap  **Connections** > **Mobile hotspot and tethering** > **Mobile hotspot**.
2. Tap  **More options** > **Timeout settings**, and then select an interval.

## Wi-Fi sharing

Turn on Wi-Fi sharing to quickly share your Wi-Fi network with other devices without giving out your Wi-Fi password.

1. From Settings, tap  **Connections** > **Mobile hotspot and tethering** > **Mobile hotspot**.
2. Tap **Wi-Fi sharing** to turn on this feature.



## Tethering

You can use tethering to share your device's Internet connection with another device.

1. From Settings, tap  **Connections** > **Mobile hotspot and tethering**.
2. Tap an option:
  - Tap **Bluetooth tethering** to share your device's Internet connection using Bluetooth.
  - Connect the computer to the device using a USB cable, and then tap **USB tethering**.



## Nearby device scanning

Easily set up connections to other available devices by turning on Nearby device scanning. This feature sends you a notification when there are available devices to connect to.

1. From Settings, tap  **Connections** > **More connection settings** > **Nearby device scanning**.
2. Tap  to turn on the feature.

## Connect to a printer



Connect your device to a printer on the same Wi-Fi network to easily print documents and images from your device.

1. From Settings, tap  **Connections** > **More connection settings** > **Printing**.
2. Tap  **Download plugin** and follow the prompts to add a print service.
3. Tap the print service, and then tap  **More options** > **Add printer**.

 **NOTE** Not all apps support printing.



## Virtual Private Networks

A Virtual Private Network (VPN) allows you to connect to a private secured network from your device. Connection information is needed from your VPN administrator, and you need to set a secure screen lock on your device.

1. From Settings, tap  **Connections** > **More connection settings** > **VPN**.
2. Tap  **More options** > **Add VPN profile**.
3. Enter the VPN network information provided by your network administrator, and tap **Save**.

## Manage a VPN

Use the VPN settings menu to edit or delete a VPN connection.

1. From Settings, tap  **Connections** > **More connection settings** > **VPN**.
2. Tap  **Settings** next to a VPN.
3. Edit the VPN and tap **Save**, or tap **Delete** to remove the VPN.

## Connect to a VPN

Once you have set up a VPN, connecting to and disconnecting from a VPN is easy.

1. From Settings, tap  **Connections** > **More connection settings** > **VPN**.
2. Tap a **VPN**, enter your log in information, and tap **Connect**.
  - To disconnect, tap the VPN, and then tap **Disconnect**.

## Private DNS

You can configure your device to connect to a private DNS host.

1. From Settings, tap  **Connections** > **More connection settings** > **Private DNS**.
2. Tap one of the available options to configure a private DNS connection.
3. Tap **Save**.

## Ethernet

If wireless network connection is not available, you can use an Ethernet cable to connect your device to a local network. You need an adapter (not included) to connect an Ethernet cable to your device.

1. Connect an Ethernet cable to your device.
2. From Settings, tap  **Connections** > **More connection settings** > **Ethernet**, and follow the prompts.

## Sounds and vibration

You can control the sounds and vibrations used to indicate notifications, screen touches, and other interactions.

### Sound mode

You can change the sound mode on your device without using the volume keys.

- From Settings, tap  **Sounds and vibration** > **Sound mode**, and then choose a mode:
  - **Sound**: Use the sounds, vibrations, and volume levels you have chosen in Sound settings for notifications and alerts.
  - **Vibrate**: Use vibration only for notifications and alerts.
  - **Mute**: Set your device to make no sounds.
    - **Temporary mute**: Set a time limit for muting the device.

 **TIP** Use the sound mode setting instead of the volume keys to change the sound mode without losing your customized sound levels.

## Easy mute

Quickly mute sounds by covering the screen or turning the device over.

- From Settings, tap  **Advanced features** > **Motions and gestures** > **Easy mute**, and tap  to enable.

## Vibrations

You can control how and when your device vibrates

1. From Settings, tap  **Sounds and vibration**.
2. Tap options to customize:
  - **Vibrate while ringing**: Set your device to vibrate in addition to ringing when you receive a call.
  - **Vibration pattern**: Choose from preset vibration patterns.

## Ringtone

Customize your call ringtone by choosing from preset sounds or adding your own.

1. From Settings, tap  **Sounds and vibration** > **Ringtone**.
2. Tap a ringtone to hear a preview and select it, or tap **Add** to use an audio file as a ringtone.

## Notification sounds

Choose a preset sound for all notification alerts.

1. From Settings, tap  **Sounds and vibration** > **Notification sounds**.
2. Tap a sound to hear a preview and select it.

 **TIP** You can also customize notifications sounds to be unique for each app using the Apps settings menu.



## Volume

Set the volume level for notifications and other audio.

- From Settings, tap  **Sounds and vibration** > **Volume**, and drag the sliders.

 **TIP** You can also use the **Volume** key to adjust the volume. Slide the volume controls to customize all volume options.



## Use Volume keys for media

Set the default of the Volume key to control the media volume.

1. From Settings, tap  **Sounds and vibration**.
2. Tap **Use Volume keys for media** to enable this feature.

## Media volume limiter

Limit the maximum output of the device's volume while using headphones or Bluetooth speakers (not included).

1. From Settings, tap  **Sounds and vibration** > **Volume**.
2. Tap  **More options** > **Media volume limiter**.
3. Tap  to enable this feature.
  - To set the maximum output volume, drag the **Custom volume limit** slider.
  - To require a PIN to make changes to the volume setting, tap **Set volume limit PIN**.

## System sounds

Customize your device's sounds and vibrations for actions like tapping the screen and charging the device.

- From Settings, tap  **Sounds and vibration** > **System sounds** for the following options:
  - **Touch sound**: Play tones when you touch or tap the screen to make selections.
  - **Screen lock sound**: Play a sound when you unlock the screen.
  - **Charging sound**: Play a sound when a charger is connected.

- **Dialing keypad tone:** Play a tone when dialing numbers on the Phone keypad.
- **Keyboard sound:** Play a sound when typing with the Samsung keyboard.

## Dolby Atmos

Enjoy Dolby Atmos quality when playing content that was specifically mixed for Atmos. This feature may only be available with a headset connected.

1. From Settings, tap  **Sounds and vibration** > **Advanced sound settings** > **Sound quality and effects**.
2. Tap **Dolby Atmos** to experience breakthrough audio that flows above and around you.

## Equalizer

Choose an audio preset that is customized to different genres of music, or manually change your audio settings.

1. From Settings, tap  **Sounds and vibration** > **Advanced sound settings** > **Sound quality and effects**.
2. Tap **Equalizer** to choose a music genre.



## Headset audio options



Enhance the sound resolution of music and videos for a clearer listening experience. These features are only available with a headset connected.

- From Settings, tap  **Sounds and vibration** > **Advanced sound settings** > **Sound quality and effects**, and tap an option to turn it on:
  - **UHQ upscaler:** Sharpens audio resolution for crisp sound.

## Adapt sound



Customize the sound for each ear and enhance your listening experience.

1. From Settings, tap  **Sounds and vibration** > **Advanced sound settings** > **Sound quality and effects** > **Adapt sound**.
2. Tap the sound profile that fits you best, and tap  **Settings** to customize.

 **TIP** Tap  **Add personalized sound profile** to have your device identify the best sound profile for you.

## Separate app sound

You can play media sound on a speaker or headphones separate from the rest of the sounds on your device. Connect to a Bluetooth device to make this option available in the Audio device menu.

1. From Settings, tap  **Sounds and vibration** > **Advanced sound settings** > **Separate app sound**.
2. Tap  to enable Separate app sound, and then set the following options:
  - **App:** Choose an app to play its sound on a separate audio device.
  - **Audio device:** Choose the audio device that you want the app's sound to be played on.

## Notifications

You can prioritize and streamline app alerts by changing which apps send notifications and how notifications alert you.

## Manage notifications

You can configure notifications from apps and services.

- From Settings, tap  **Notifications**.
  - **App icon badges:** Identify which apps have active notifications with badges that appear on their icons. Tap to choose whether or not badges indicate the number of unread notifications.

- **Do not disturb:** Block sounds and notifications while this mode is turned on. Specify exceptions for people, apps, and alarms.
- **Status bar:** Modify how many notifications appear on the Status bar.
- To block notifications from an app, tap  next to the app. Tap **See all** to open the complete list of apps.

## Customize app notifications

You can change notification settings for each app.

1. From Settings, tap  **Notifications** > **See all**.
2. Tap an app for the following options:
  - **Show notifications:** Receive notifications from this app.
  - **App icon badges:** Show a badge on the icon when there are notifications.
  - **Categories:** Configure notification options that are specific to this app.

## Smart pop-up view

Receive notifications as icons that can be tapped and expanded in pop-up view.

- From Settings, tap  **Advanced features** > **Smart pop-up view**, and tap  to enable.

## Display

You can configure the screen brightness, timeout delay, font size, and many other display settings.

### Screen brightness

Adjust the screen brightness according to lighting conditions or personal preference.

1. From Settings, tap  **Display**.
2. Customize options under Brightness:
  - Drag the **Brightness** slider to set a custom brightness level.
  - Tap **Adaptive brightness** to automatically adjust the screen brightness based on the lighting conditions.



## Night mode

Night mode allows you to switch to a darker theme to keep your eyes more comfortable at night.

- From Settings, tap  **Display** > **Night mode** for the following options:
  - **Turn on now:** Put your device in Night mode.
  - **Turn on as scheduled:** Configure Night mode for either **Sunset to sunrise** or **Custom schedule**.

## Font size and style

You can change the font size and style to customize your device.

- From Settings, tap  **Display** > **Font size and style** for the following options:
  - Drag the **Font size** slider to adjust the size of text.
  - Tap **Font style** to choose a different font.
    - Tap a font to select it, or tap  **Download fonts** to add fonts from Galaxy Store.
  - Tap **Bold font** to make all fonts appear with bold weight.

## Screen zoom

Adjust the zoom level to increase or decrease the size of content on the screen.

1. From Settings, tap  **Display** > **Screen zoom**.
2. Drag the **Screen zoom** slider to adjust the zoom level.

## Screen timeout

You can set the screen to turn off after a set amount of time.

- From Settings, tap  **Display** > **Screen timeout**, and tap a time limit to set it.

## Accidental touch protection

Prevent the screen from detecting touch input while the device is in a dark place, such as a pocket or a bag.

- From Settings, tap  **Display** > **Accidental touch protection** to enable or disable the feature.



## Touch sensitivity



Increase the touch sensitivity of the screen for use with screen protectors.

- From Settings, tap  **Display** > **Touch sensitivity** to enable.

## Screen saver

You can display colors or photos when the screen turns off or while charging.

1. From Settings, tap  **Display** > **Screen saver**.
2. Tap  to enable the feature and configure the following options:
  - **Colors:** Tap the selector to display a changing screen of colors.
  - **Photo table:** Display pictures in a photo table.
  - **Photo frame:** Display pictures in a photo frame.
  - **Photos:** Display pictures from your Google Photos account.
3. Tap **Preview** for a demonstration of the selected Screen saver.

 **TIP** Tap  **Settings** next to a feature for additional options.



## Reduce animations

Decrease certain motion effects, such as when opening apps.

- From Settings, tap  **Advanced features** > **Reduce animations**, and tap  to enable the feature.

## Double tap to wake

Turn on the screen by double-tapping instead of using the Side key.

- From Settings, tap  **Advanced features** > **Motions and gestures** > **Double tap to wake**, and tap  to enable.

## Smart stay

Smart stay uses the front camera to detect your face so that the screen stays on while you are looking at it.

- From Settings, tap  **Advanced features** > **Motions and gestures** > **Smart stay**, and tap  to enable the feature.

## Device maintenance

View the status of your device's battery, storage, and memory. You can also automatically optimize your device's system resources.

## Quick optimization

The quick optimization feature improves device performance through the following actions:



- Identifying apps that use excessive battery power and clearing unneeded items from memory.
- Deleting unnecessary files and closing apps running in the background.
- Scanning for malware.

To use the quick optimization feature:

- From Settings, tap  **Device care** > **Optimize now**.

## Battery

View how battery power is used for your various device activities.

- From Settings, tap  **Device care** > **Battery** for options:
  - **Battery usage:** View power usage by app and service.
  - **Power mode:** Select a power mode to extend battery life.
  - **Usage by apps:** View power usage by app today or over the past week.
  -  **More options** > **Settings:** Configure advanced battery settings and notifications.

## Storage

View the device storage and usage. You can also mount, unmount, or format an optional memory card (not included).

### Device storage

Quickly optimize your device's storage, increasing available memory.

- From Settings, tap  **Device care** > **Storage** > **Clean now**.



### Memory card

Once an optional microSD memory card (not included) has been installed in your device, the card memory is displayed in the Storage setting.

For more information, see [Assemble your device](#) on page 5.

### Mount a memory card



When you install an optional memory card, it is automatically mounted (connected to the device) and prepared for use. However, should you unmount the card without removing it from the device, you need to mount it before it can be accessed.

1. From Settings, tap  **Device care** > **Storage**.
2. Tap  **More options** > **Storage settings**.
3. Under **Portable storage**, tap your SD card, and then tap **Mount**.





## Remove a memory card

To prevent damage to information stored on the memory card, unmount the card before removing it from the device.

1. From Settings, tap  **Device care** > **Storage**.
2. Tap  **More options** > **Storage settings**.
3. Under **Portable storage**, tap your SD card, and then tap **Unmount**.
4. Remove your memory card from the device.

## Format a memory card

When formatting an SD card, you should back up your music and photo files that are stored on the card because formatting the SD card deletes **ALL** stored files.

1. From Settings, tap  **Device care** > **Storage**.
2. Tap  **More options** > **Storage settings**.
3. Under **Portable storage**, tap your SD card, tap **Format**, and then follow the prompts.

## Memory

Check the amount of available memory. You can close background apps and reduce the amount of memory you are using to speed up your device.

1. From Settings, tap  **Device care** > **Memory**.
  - The used and available memory are shown.
2. To free up as much memory as possible, tap **Clean now** and follow the prompts.
  - The selected apps and services in the list will be closed.

## Security

Scan your device with anti-malware to keep it secure and protected from suspicious activities.



1. From Settings, tap  **Device care** > **Security**.
2. Tap **Activate** to scan your device.

## Language and input

Configure your device's language and input settings.

### Change the device language

You can add languages to your list and organize them according to preference. If an app does not support your default language, then it will move to the next supported language in your list.

1. From Settings, tap  **General management** > **Language and input** > **Language**.
2. Tap  **Add language**, and select a language from the list.
3. Tap **Set as default** to change the device language.
  - To switch to another language on the list, drag  **Move** next to the desired language to the top of the list, and then tap **Apply**.

### Default keyboard

You can select a default keyboard for your device's menus and keyboards. Additional keyboards can be downloaded from the Google Play store.

1. From Settings, tap  **General management** > **Language and input**.
2. Tap **Default keyboard**, and select a keyboard.



### Google Voice typing

Speak rather than type your text entries using Google Voice™ typing.

1. From Settings, tap  **General management** > **Language and input**.
2. Tap **On-screen keyboard** > **Google Voice typing** to customize settings.

### Manage on-screen keyboards

Enable or disable on-screen keyboards.

1. From Settings, tap  **General management** > **Language and input**.
2. Tap **On-screen keyboard** >  **Manage keyboards**.
3. Tap each keyboard to enable or disable.

## Physical keyboards

Customize options when you have a physical keyboard connected to your device (sold separately).

1. From Settings, tap  **General management** > **Language and input**.
2. Tap **Physical keyboard**, and then choose an option:
  - **Show on-screen keyboard**: Show the on-screen keyboard while a physical keyboard is also being used.
  - **Keyboard shortcuts**: Show explanations of the keyboard shortcuts on the screen.



## Autofill service

Save time entering information using autofill services.

1. From Settings, tap  **General Management** > **Language and input**.
2. Tap **Autofill service** and select your preferred service.

## Text-to-speech

Configure your Text-to-Speech (TTS) options. TTS is used for various accessibility features, such as Voice Assistant.

- From Settings, tap  **General management** > **Language and input** > **Text-to-speech** for options:
  - **Preferred engine**: Choose either the Samsung or Google Text-to-speech engine. Tap  **Settings** for options.
  - **Language**: Set the default speech language.
  - **Speech rate**: Set the speed at which the text is spoken.
  - **Pitch**: Set the pitch of the speech.
  - **Play**: Tap to play a short demonstration of speech synthesis.
  - **Reset**: Reset the speech rate and pitch.

## Pointer speed

Configure pointer speed for an optional mouse or trackpad (not included).

1. From Settings, tap  **General management** > **Language and input**.
2. Under **Pointer speed**, drag the slider to the right to go faster or to the left to go slower.

## Primary mouse button

You can define which mouse button that you favor as primary.

1. From Settings, tap  **General management** > **Language and input**.
2. Tap **Primary mouse button**, and choose either **Left** or **Right**.

## Date and time

By default, your device receives date and time information from the wireless network. Outside of network coverage, you can set the date and time manually.

- From Settings, tap  **General management** > **Date and time**. The following options are available:
  - **Automatic date and time**: Receive date and time updates from your wireless network. When Automatic date and time is disabled, the following options are available:
    - **Select time zone**: Choose a new time zone.
    - **Set date**: Enter the current date.
    - **Set time**: Enter the current time.
  - **Use 24-hour format**: Set the format for displaying time.

## Troubleshooting

You can also check for software updates, and if necessary, reset services on your device.

### Software update

Check for and install available software updates for your device.

- From Settings, tap  **Software update** for the following options:
  - **Download and install:** Check for software updates and install if any are available.
  - **Auto download over Wi-Fi:** Automatically download software updates when the device is connected to a Wi-Fi network.
  - **Last update:** View information about the installation of the current software.

### Reset

Reset device and network settings. You can also reset your device to its factory defaults.

#### Reset settings

You can reset your device to its factory default settings, which resets everything except the security, language, and account settings. Personal data is not affected.

1. From Settings, tap  **General management** > **Reset** > **Reset settings**.
2. Tap **Reset settings**, and confirm when prompted.

#### Reset network settings

You can reset Wi-Fi, mobile data, and Bluetooth settings with Reset network settings.

1. From Settings, tap  **General management** > **Reset** > **Reset network settings**.
2. Tap **Reset settings**, and confirm when prompted.



## Reset accessibility settings

You can reset device accessibility settings. Accessibility settings in downloaded apps and your personal data are not affected.

1. From Settings, tap  **General management** > **Reset** > **Reset accessibility settings**.
2. Tap **Reset settings**, and confirm when prompted.

## Auto restart

Optimize your device by restarting it automatically at set times. Any unsaved data will be lost when the device restarts.

1. From Settings, tap  **General management** > **Reset** > **Auto restart**.
2. Tap  to activate Auto restart, and then set the following parameters:
  - **Days:** Select the day of the week to automatically restart your device.
  - **Time:** Set the time of day to restart your device.

## Factory data reset

You can reset your device to factory defaults, erasing all data from your device.

This action permanently erases ALL data from the device, including Google or other account settings, system and application data and settings, downloaded applications, as well as your music, photos, videos, and other files. Any data stored on an external SD card is not affected.

When you sign in to a Google Account on your device, Factory Reset Protection is activated. This protects your device in the event it is lost or stolen.

If you reset your device to factory default settings with the Factory Reset Protection (FRP) feature activated, you must enter the user name and password for a registered Google Account to regain access to the device. You will not be able to access the device without the correct credentials.

 **NOTE** If you reset your Google Account password, it can take 24 hours for the password reset to sync with all devices registered to the account.

Before resetting your device:

1. Verify that the information you want to keep has transferred to your storage area.
2. Log in to your Google Account and confirm your user name and password.

To reset your device:

1. From Settings, tap  **General management** > **Reset** > **Factory data reset**.
2. Tap **Reset** and follow the prompts to perform the reset.
3. When the device restarts, follow the prompts to set up your device.

## Factory reset protection

When you sign in to a Google Account on your device, Factory Reset Protection is activated. Factory Reset Protection (FRP) prevents other people from using your device if it is reset to factory settings without your permission. For example, if your device is lost or stolen and a factory data reset is performed, only someone with your Google Account username and password can use the device.

You will not be able to access the device after a factory data reset if you do not have your Google Account username and password.

 **CAUTION** Before sending your device to Samsung or taking it to a Samsung-authorized service center, remove your Google Account and then perform a factory data reset. For more information, visit [samsung.com/us/support/frp](https://samsung.com/us/support/frp).

## Enable factory reset protection

Adding a Google Account to your device automatically activates the FRP security feature.

## Disable factory reset protection

To disable FRP, remove all Google Accounts from the device.

1. From Settings, tap  **Accounts and backup** > **Accounts** > [Google Account].
2. Tap **Remove account**.

# Lock screen and security

You can secure your device and protect your data by setting a screen lock.



## Screen lock types

You can choose from the following screen lock types that offer high, medium, or no security: Swipe, Pattern, PIN, Password, and None.

 **NOTE** Biometric locks are also available to protect access to your device and sensitive data on your device. For more information, see **Flexible security** on page 35.

## Set a secure screen lock

It is recommended that you secure your device using a secure screen lock (Pattern, PIN, or Password).

1. From Settings, tap  **Lock screen** > **Screen lock type** and tap a secure screen lock (**Pattern**, **PIN**, or **Password**).
2. Tap  to enable showing notifications on the lock screen. The following options are available:
  - **View style:** Display notification details or hide them and show only an icon.
  - **Hide content:** Do not show notifications in the notification panel.
3. Tap **Done** when finished.
4. Configure the following screen lock options:
  - **Smart Lock:** Unlock your device automatically when trusted locations or other devices have been detected. A secure screen lock is required for this feature.
  - **Secure lock settings:** Customize your secure lock settings. A secure screen lock is required for this feature.



## Clock and information

You can configure features that appear on the Lock screen, like the clock and other useful information.

- From Settings, tap  **Lock screen** for the following options:
  - **Clock style:** Set the type and color of the clock on the Lock screen.
  - **Roaming clock:** Change to digital clocks showing both local and home time zones when roaming.
  - **FaceWidgets:** Enable widgets on the Lock screen to get quick access to useful information.
  - **Contact information:** Show your contact information, such as your phone number or email address.
  - **Notifications:** Select which notifications to display on the Lock screen.
  - **App shortcuts:** Select which apps to open from the Lock screen.
  - **About Lock screen:** Update the Lock screen's software.

## Google Play Protect

You can configure Google Play Protect to regularly check your apps and device for security risks and threats.



1. From Settings, tap  **Biometrics and security** > **Google Play Protect**.
2. Tap options to customize security features.

## Find My Mobile

You can protect your device from loss or theft by allowing your device to be locked, tracked online, and for your data to be deleted remotely. A Samsung account is required, and Google location service must be turned on in order to use Find My Mobile. For more information, visit [samsung.com/us/support/owners/app/find-my-mobile](https://samsung.com/us/support/owners/app/find-my-mobile).

## Turn on Find My Mobile

Before you can use the Find My Mobile feature, you must turn it on and customize the options. To access your device remotely, visit [findmymobile.samsung.com](https://findmymobile.samsung.com).

1. From Settings, tap  **Biometrics and security** > **Find My Mobile**.
2. Tap  to enable Find My Mobile and log in to your Samsung account. The following options are available:
  - **Remote unlock:** Allow Samsung to store your PIN, pattern, or password, allowing you to unlock and control your device remotely.
  - **Send last location:** Allow your device to send its last location to the Find My Mobile server when the remaining battery charge falls below a certain level.

## Security update

You can easily check the date of the last installed security software update and find out if newer updates are available.

- From Settings, tap  **Biometrics and security** > **Security update** to see the latest security update installed and check if a newer update is available.

## Samsung Pass

Use Samsung Pass to access your favorite services with biometric data. You must sign in to your Samsung account to use Samsung Pass.

Visit [samsung.com/us/support/owners/app/samsung-pass](https://samsung.com/us/support/owners/app/samsung-pass) to learn more.

1. From Settings, tap  **Biometrics and security** > **Samsung Pass**.
2. Sign in to your Samsung account and add your biometric data.

## Install unknown apps

You can allow installation of unknown third-party apps from selected apps or sources.

1. From Settings, tap  **Biometrics and security** > **Install unknown apps**.
2. Tap an app or source, and then tap **Allow from this source**.

 **TIP** Installing unknown third-party apps could make your device and personal data more vulnerable to security risks.

## Secure Folder

You can create a secure folder on your device to protect private content and apps from anyone who may be using your device. You must sign in to your Samsung account to set up and use Secure folder.

- From Settings, tap  **Biometrics and security** > **Secure Folder** and follow the prompts to secure content on your device.

## Encrypt SD card

You can encrypt your optional memory card (not included) to protect its data. This only allows the SD card information to be accessed from your device with a password.

1. From Settings, tap  **Biometrics and security** > **Encrypt SD card**.
2. Tap **Encrypt SD card** and follow the prompts to encrypt all data on your memory card.

 **NOTE** Performing a Factory data reset on your device prevents it from accessing an encrypted SD card. Before initiating a Factory data reset, make sure to decrypt the installed SD card first.

## Decrypt SD card

You can decrypt an optional memory card (not included) if it was encrypted by this device. You may want to decrypt the memory card if you plan to use it with another device or before performing a Factory data reset.

1. From Settings, tap  **Biometrics and security** > **Decrypt SD card**.
2. Tap **Decrypt SD card** and follow the prompts to decrypt all data on your memory card.

## View passwords

You can have characters displayed briefly in password fields as you type them.

- From Settings, tap  **Biometrics and security** > **Other security settings** > **Make passwords visible** to turn on the feature.

## Security update service

You can set your device to automatically check for security updates.

- From Settings, tap  **Biometrics and security** > **Other security settings**, and then tap **Security policy updates** to check for security updates.

## Device administration

You can authorize security features and apps (like Find My Mobile) to have administrative access to your device.

1. From Settings, tap  **Biometrics and security** > **Other security settings** > **Device admin apps**.
2. Tap an option to turn it on as a device administrator.



## Credential storage

You can manage the trusted security certificates installed on your device, which verify the identity of servers for secure connections.

- From Settings, tap  **Biometrics and security** > **Other security settings** for the following options:
  - **Storage type:** Select a storage location for credential contents.
  - **View security certificates:** Display certificates in your device's ROM and other certificates you have installed.
  - **User certificates:** View user certificates that identify your device.
  - **Install from device storage:** Install a new certificate from storage.
  - **Clear credentials:** Erase credential contents from the device and reset the password.

## Strong protection

Better protect your device by encrypting it using a secure lock type.

- From Settings, tap  **Biometrics and security** > **Other security settings** > **Strong protection**, and then tap  to enable this feature.



## Advanced security settings

You can use these options to configure advanced security settings to better protect your device.

- From Settings, tap  **Biometrics and security** > **Other security settings** for the following options:
  - **Trust agents:** Allow trusted devices to perform selected actions when connected.
    - This option is only displayed when a lock screen is turned on. For more information, see [Set a secure screen lock](#) on page 117.
  - **Pin windows:** Pin an app on your device screen, which prevents access to other features of your device.

## Location



Location services use a combination of GPS, mobile network and Wi-Fi to determine the location of your device.

1. From Settings, tap  **Biometrics and security** > **Location**.
2. Tap  to turn on Location services.
3. Tap **Improve accuracy** to use other connections for determining your location:
  - **Wi-Fi scanning:** Allow apps and services to scan for Wi-Fi networks automatically, even when Wi-Fi is turned off.
  - **Bluetooth scanning:** Allow apps to scan for and connect to nearby devices automatically through Bluetooth, even when Bluetooth is turned off.

 **TIP** Some apps require location services be turned on for full functionality.

## Recent location requests

View a list of apps that have requested your location.

1. From Settings, tap  **Biometrics and security** > **Location**.
2. Tap  to turn on Location services.
3. Tap an entry under **Recent location requests** to view the app's settings.



## Location services

Location services store and use your device's most recent location data. Certain apps can use this data to improve your search results based on places that you have visited.

1. From Settings, tap  **Biometrics and security** > **Location**.
2. Tap an entry under **Location services** to see how your location information is used.

## App permissions

Apps might access features of your device that you permit them to (like the camera, microphone, or location) when they are running in the background, not just when you are using the app. You can set your device to notify you when this happens.

1. From Settings, tap  **Biometrics and security** > **App permissions**.
2. Tap a category, and tap  next to the apps you want to be notified about.
  - Tap an app to select which permissions you want to be notified about.

## Send diagnostic data

Send diagnostic information about your device to Samsung when you are having technical problems.



1. From Settings, tap  **Biometrics and security** > **Send diagnostic data**.
2. Read and accept the consent information to enable this feature.

# Accounts

You can connect to and manage your accounts, including your Google Account, Samsung account, email, and social networking accounts.

## Add an account

You can add and sync all your email, social networking, and picture and video sharing accounts.

1. From Settings, tap  **Accounts and backup** > **Accounts** >  **Add account**.
2. Tap one of the account types.
3. Follow the prompts to enter your credentials and set up the account.
  - Tap **Auto sync data** to enable automatic updates to your accounts.

## Account settings

Each account has its own custom settings. You can configure common settings for all accounts of the same type. Account settings and available features vary between account types.

1. From Settings, tap  **Accounts and backup** > **Accounts**.
2. Tap an account to configure that account's sync settings.
3. Tap other available options for the account type.

## Remove an account

You can remove accounts from your device.

1. From Settings, tap  **Accounts and backup** > **Accounts**.
2. Tap the account and then tap **Remove account**.

## Users



Share this tablet with multiple people by creating User accounts.

Users have their own space, which they can customize with their own apps, wallpaper, and settings. Users can also adjust tablet settings that affect everyone, such as Wi-Fi.

1. From Settings, tap  **Accounts and backup** > **Users**.
2. Tap **Add user or profile** and follow the prompts to set up a new user or profile.

 **TIP** Restricted profiles allow only limited access to apps and content.

## Delete a User or Profile

1. From Settings, tap  **Accounts and backup** > **Users**.
  - For a restricted account, tap  **Settings** next to the user profile.
2. Tap  **Delete**, and then confirm when prompted.

 **NOTE** Only the device owner can delete other users or profiles. Deleting a user's profile removes the user account from the device entirely. This includes the user's Google Account, Samsung account, and any other local accounts associated with the user.

## Samsung Cloud

You can keep your data safe by backing up and restoring your device. You can also sync your data from multiple devices. For more information, visit [samsung.com/us/support/owners/app/samsung-cloud](https://samsung.com/us/support/owners/app/samsung-cloud).

1. From Settings, tap  **Accounts and backup** > **Samsung Cloud**.
  - If a Samsung account has not been added, the screens explain how to create or sign in to your account.
2. Once a Samsung account is configured, you can view and manage items stored in the Samsung Cloud.



## Backup and restore

You can configure your device to back up data to your personal accounts.

### Samsung account

You can enable backup of your information to your Samsung account.

- From Settings, tap  **Accounts and backup** > **Backup and restore** for options:
  - **Back up data:** Configure your Samsung account to back up your data.
  - **Restore data:** Use your Samsung account to restore your backup data.

### Google Account

You can enable backup of your information to your Google Account.

- From Settings, tap  **Accounts and backup** > **Backup and restore** for options:
  - **Back up my data:** Enable back up of application data, Wi-Fi passwords, and other settings to Google servers.
  - **Backup account:** Select a Google Account to be used as your backup account.
  - **Automatic restore:** Enable automatic restoration of settings from Google servers.

### External storage transfer

You can back up your data to an SD card or a USB storage device, or restore backup data using Smart Switch. For more information, see [Transfer data from an old device](#) on page 15.

- From Settings, tap  **Accounts and backup** > **Backup and restore** > **External storage transfer**.

## Google settings

You can configure your device's Google settings. Available options depend on your Google Account.

- From Settings, tap  **Google**, and select an option to customize.

# Accessibility

There are accessibility settings for people who need help seeing, hearing, or otherwise operating their device. Accessibility services are special features that make using the device easier for everyone. For more information about Accessibility for Samsung products, please contact us at [accessibility@sea.samsung.com](mailto:accessibility@sea.samsung.com).

## Screen reader

Use special controls and settings that let you navigate without needing to see the screen.

- From Settings, tap  **Accessibility** > **Screen reader** and tap an option:
  - **Voice assistant:** Receive spoken feedback when using your device, such as what you touch, select, or activate.
  - **Tutorial:** Learn how to use Voice assistant.
  - **Settings:** Configure Voice assistant to better assist you.

## Visibility enhancements

You can configure Accessibility features to assist with visual aspects of your device.

### Colors and clarity

You can adjust the colors and contrast of text and other screen elements for easier viewing.

- From Settings, tap  **Accessibility** > **Visibility enhancements** and tap an option:
  - **High contrast fonts:** Adjust the color and outline of fonts to increase the contrast with the background.
  - **High contrast keyboard:** Adjust the size of the Samsung keyboard and change its colors to increase the contrast between the keys and the background.
  - **Show button shapes:** Show buttons with shaded backgrounds to make them stand out better against the wallpaper.
  - **Remove animations:** Remove certain screen effects if you are sensitive to motion.

- **Color inversion:** Reverse the display of colors from white text on a black background to black text on a white background.
- **Color correction:** Adjust the color of the screen if you find it difficult to see some colors.

### Size and zoom

You can increase the size of supported screen elements and create shortcuts for accessibility features on your device.

- From Settings, tap  **Accessibility** > **Visibility enhancements** and tap an option:
  - **Magnifier window:** Magnify content shown on the screen.
  - **Magnification:** Use exaggerated gestures such as triple-tapping, double pinching, and dragging two fingers across the screen.
  - **Large mouse/touchpad pointer:** Use a large pointer for a connected mouse or touchpad (accessories not included).
  - **Font size and style:** Configure screen fonts.
  - **Screen zoom:** Configure the screen zoom level.

### Hearing enhancements

You can configure Accessibility features to assist with audial aspects of the device.

### Sounds

You can adjust audio quality when using hearing aids or earphones.

- From Settings, tap  **Accessibility** > **Hearing enhancements** and tap an option:
  - **Sound detectors:** Receive alerts when the device detects a baby crying or a doorbell.
  - **Mute all sounds:** Turn off all notifications and audio for privacy.
  - **Left/right sound balance:** Use the slider to adjust the left and right balance when listening to audio in stereo.
  - **Mono audio:** Switch audio from stereo to mono when using one earphone.

## Text display

You can watch closed captions when viewing multimedia.

- From Settings, tap  **Accessibility** > **Hearing enhancements** and tap an option:
  - **Samsung subtitles (CC)**: Use Samsung subtitles with multimedia files when available.
  - **Google subtitles (CC)**: Use Google subtitles with multimedia files when available.

## Interaction and dexterity

You can configure Accessibility features to assist with limited dexterity when interacting with your device.

### Alternate input

You can control your device using different kinds of inputs and controls.

- From Settings, tap  **Accessibility** > **Interaction and dexterity** and tap an option:
  - **Universal switch**: Control your device with your customized switches.
  - **Assistant menu**: Improve device accessibility for users with reduced dexterity.
  - **Click after pointer stops**: Automatically click on an item after the pointer stops over it.

### Interactions

You can simplify the motions needed to respond to notifications and alarms.

- From Settings, tap  **Accessibility** > **Interaction and dexterity** and tap an option:
  - **Interaction control**: Customize areas of screen interactions, hardkeys, and the keyboard.

## Touch settings

You can adjust your screen to be less sensitive to taps and touches.

- From Settings, tap  **Accessibility** > **Interaction and dexterity** and tap an option:
  - **Touch and hold delay:** Select a time interval for this action.
  - **Tap duration:** Set how long an interaction must be held to be recognized as a tap.
  - **Ignore repeated touches:** Set a time duration in which to ignore repeated touches.

## Advanced settings

You can customize additional accessibility features and services for your device.

 **TIP** Additional accessibility apps may be downloaded from the Google Play store.

## Direct access

- From Settings, tap  **Accessibility** > **Advanced settings** and tap an option:
  - **Side and Volume up keys:** Configure selected Accessibility settings to open by quickly pressing the Side and Volume up keys at the same time.
  - **Volume up and down keys:** Configure selected services to turn on when you press and hold the Volume up and Volume down keys for three seconds.

## Notifications

- From Settings, tap  **Accessibility** > **Advanced settings** and tap an option:
  - **Flash notification:** Flash either the camera light or the screen when you receive notifications or when alarms sound.
  - **Notification reminders:** Set periodic reminders for any unread notifications.

## Installed services

You can install additional assistance services for your device.

- From Settings, tap  **Accessibility** > **Installed services**.

 **NOTE** Additional accessibility services are listed and configured here after they are installed.

## Other settings

Configure features on your device that make it easier to use.



## Help

View the user manual on your device.

- From Settings, tap  **Help**.

## Daily Board

View a slideshow of your photos when your tablet is charging.

1. From Settings, tap  **Advanced features** > **Daily Board**.
2. Tap  to enable **Daily Board**.
3. Choose one of the following options:
  - **Slideshow**: Enable a button that launches a slideshow of images from Gallery.
  - **Time, weather, and calendar**: Display the current time, current weather, and a calendar.
  - **Memo**: Create memos while the device is charging.
  - **Music**: Set music to play while the device is charging.
  - **Auto start**: Start the slideshow automatically when the device is put into charging mode.
  - **Turn off as scheduled**: Set a schedule time to turn the device off.
    - **Set time**: Select a turn off time.
  - **About Daily Board**: View the app version and other information.

## About tablet

View information about your device, including current status, legal information, hardware and software versions, and more.

1. From Settings, tap  **About tablet**, and then view your model number, serial number, and IMEI information.
2. Tap additional items to view more information about your device.

 **TIP** You can view your device's FCC ID from **About tablet > Status**.

# Learn more

---

## Videos

[samsung.com/us/support/videos](https://samsung.com/us/support/videos)

## Smart Simulator

[samsungsimulator.com](https://samsungsimulator.com)

## Tips

[samsung.com/us/support/tips](https://samsung.com/us/support/tips)

## Samsung Care

[samsung.com/us/support](https://samsung.com/us/support)

## Talk to an agent

Contact us on Facebook Messenger

Find us on Facebook

Follow us on Twitter



# Legal information

---

READ THIS INFORMATION BEFORE USING YOUR MOBILE DEVICE.

Arbitration Agreement - This Product is subject to a binding arbitration agreement between you and SAMSUNG ELECTRONICS AMERICA, INC. (“Samsung”). You can opt out of the agreement within 30 calendar days of the first consumer purchase by emailing [optout@sea.samsung.com](mailto:optout@sea.samsung.com) or calling 1-800-SAMSUNG (726-7864) and providing the applicable information.

The full Arbitration Agreement, Standard One-year Limited Warranty, End User License Agreement (EULA), and Health & Safety Information for your device are available online:

Tablet:

- English: [samsung.com/us/Legal/Tablet-HSGuide](https://samsung.com/us/Legal/Tablet-HSGuide)
- Spanish: [samsung.com/us/Legal/Tablet-HSGuide-SP](https://samsung.com/us/Legal/Tablet-HSGuide-SP)

This information can also be found on the device in the “About device” or “About phone” or “About tablet” section, for example:

- **Settings** > **About phone** or **About device** or **About tablet** > **Legal information** > **Samsung legal**
- Or, search “Legal”

If your device required Federal Communications Commission (FCC) approval, you can view the FCC certification by opening **Settings** > **About phone** or **About device** or **About tablet** > **Status**.

## Samsung Knox

Samsung Knox is Samsung’s security platform and is a mark for a Samsung device tested for security with enterprise use in mind. Additional licensing fee may be required. For more information about Knox, please refer to: [samsung.com/us/knox](https://samsung.com/us/knox).

## Restricting children's access to your mobile device

Your device is not a toy. Do not allow children to play with it because they could hurt themselves and others, or damage the device. Keep the device and all its parts and accessories out of the reach of small children.

## Samsung Electronics America, Inc.

Address:

85 Challenger Road  
Ridgefield Park  
New Jersey 07660

Phone: 1-800-SAMSUNG (726-7864)

Internet: [samsung.com](http://samsung.com)

©2019 Samsung Electronics America, Inc. Samsung, Samsung Galaxy, Multi Window, S Pen, and Smart Switch are all trademarks of Samsung Electronics Co., Ltd.

Other marks are the property of their respective owners.

Manufactured under license from Dolby Laboratories. Dolby, Dolby Atmos, and the double-D symbol are trademarks of Dolby Laboratories.



Some multimedia (audio/video) files contain Digital Rights Management (DRM) technology to verify you have the right to use the files. Preloaded apps on your device may not be compatible with DRM-protected files.

Screen images are simulated. Appearance of device may vary.

The actual available capacity of the internal memory is less than the specified capacity because the operating system and default applications occupy part of the memory. The available capacity may change when you upgrade the device.

Please check with your service provider to verify qualifying services/features.