

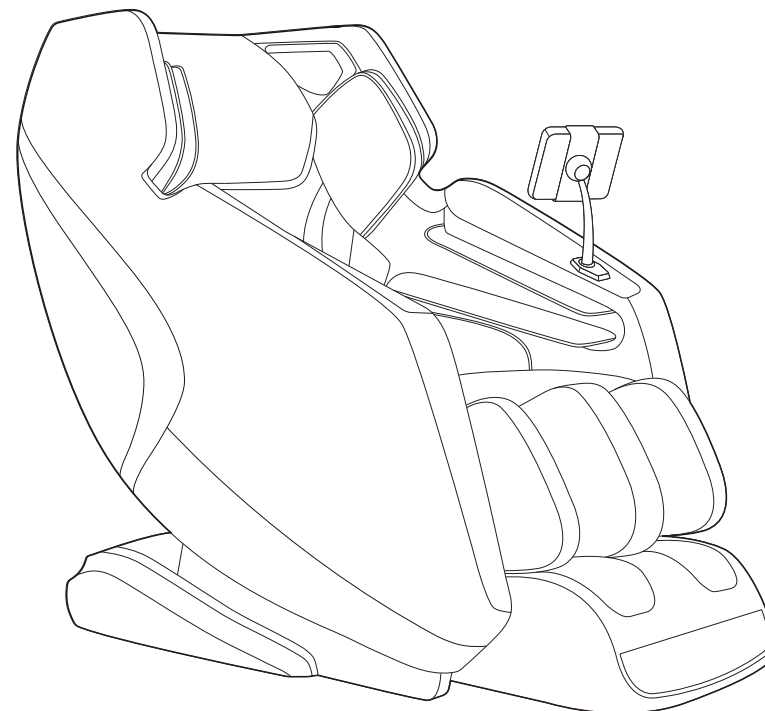

Please give us a chance to make it right and do better !

Contact our friendly customer service department for help first.
Replacements for missing or damaged parts will be shipped ASAP !

US office: Fontana **UK** office: Ipswich **AU** office: Truganina
DE office: Hamburg **FR** office: Saint Vigor d'Ymonville **PL** office: Gdańsk



Contact Us!

Do NOT return this item.

Contact our friendly customer service department for help first.



US: cs.us@costway.com
UK: cs.uk@costway.com
AU: cs.au@costway.com

USER'S MANUAL

Massage Chair JL10013

THIS INSTRUCTION BOOKLET CONTAINS **IMPORTANT** SAFETY INFORMATION. PLEASE READ AND KEEP FOR FUTURE REFERENCE.



Before You Start

- ⚠ Please read all instructions carefully.
- ⚠ Retain instructions for future reference.
- ⚠ Separate and count all parts and hardware.
- ⚠ Read through each step carefully and follow the proper order.
- ⚠ We recommend that, where possible, all items are assembled near to the area in which they will be placed in use, to avoid moving the product unnecessarily once assembled.
- ⚠ Always place the product on a flat, steady and stable surface.
- ⚠ Keep all small parts and packaging materials for this product away from babies and children as they potentially pose a serious choking hazard.

Safety

IMPORTANT SAFETY INSTRUCTIONS

This massage chair is intended for household only. When using an electrical appliance, basic precautions should always be followed, including the following:

Read all instructions before using this massage chair.

DANGER-To reduce the risk of electric shock:

- 1) Always unplug this appliance from the electrical outlet immediately after using and before cleaning.
- 2) Never use pins or other metallic fasteners with this appliance.
- 3) Carefully examine the covering before each use. Discard the appliance if the covering shows any sign of deterioration, such as checking, blistering, or cracking.
- 4) Keep Dry - Do not operate in a wet or moist condition.

WARNING-To reduce the risk of burns, fire, electric shock, or injury to persons:

- 1) An appliance should never be left unattended when plugged in. Unplug from outlet when not in use, and before putting on or taking off parts.
- 2) Do not operate under blanket or pillow. Excessive heating can occur and cause fire, electric shock, or injury to persons.
- 3) Close supervision is necessary when this appliance is used by, on, or near children, invalids, or disabled persons. Keep children away from extended foot support.
- 4) Use this appliance only for its intended use as described in this manual.

Do not use attachments not recommended by the manufacturer.

- 5) Never operate this appliance if it has a damaged cord or plug, if it is not working properly, if it has been dropped or damaged, or dropped into water.

Return the appliance to a service center for examination and repair.

- 6) Do not carry this appliance by supply cord or use cord as a handle.
- 7) Keep the cord away from heated surfaces.
- 8) Never operate the appliance with the air openings blocked. Keep the air openings free of lint, hair, and the like.
- 9) Never drop or insert any object into any opening.
- 10) Do not use outdoors.
- 11) Do not operate where aerosol (spray) products are being used or where oxygen is being administered.
- 12) To disconnect, turn all controls to the off position, then remove plug from outlet.
- 13) Temperatures sufficiently high to cause burns may occur regardless of the control setting. Do not use on an infant or invalid or on a sleeping or unconscious person. Do not use on insensitive skin or on a person with poor blood circulation. Check the skin in contact with the heated area of the appliance frequently to reduce the risk of blistering.
- 14) Do Not Crush - Avoid sharp folds.
- 15) Do not use massager in close proximity to loose clothing or jewelry.
- 16) Keep long hair away from massager while in use.
- 17) Connect this appliance to a properly grounded outlet only. See Grounding Instructions.
- 18) The apparatus shall not be exposed to dripping or splashing and that no objects filled with liquids, such as vases, shall be placed on the apparatus.
- 19) An apparatus with CL ASS I construction shall be connected to a MAINS socket outlet with a protective earthing connection
- 20) The appliance coupler is used as the disconnect device, the disconnect device shall remain readily operable.

- 21) This appliance is not intended for use by persons (including children) with reduced physical, sensory or mental capabilities, or lack of experience and knowledge, unless they have been given supervision Or instruction concerning use of the appliance by a person responsible for their safety.
- 22) If it is not in use for a long time or after use, please turn off the power and pull out the power plug.
- 23) Do not damage, break, over-bend, compress, tighten, wind, rotate or knot the power cord.

SAVE THESE INSTRUCTIONS

This massage chair is intended for household use only.

•Usage Environment

- Do not use the massage chair in an excessively humid or dusty environment as this may result in malfunction or electric shock.
- Do not use the massage chair in a room with a temperature of 104°F or higher.
- Do not expose the massage chair to heaters, stoves or direct sunlight. Place and use the massage chair on an even, non-slip floor.
- The massage chair is designed for home use and not for commercial purposes.

Caution

- The massage chair is to be used indoors only.
- If you use the massage chair in a cold room, do not increase the room temperature abruptly. It is recommended that you increase the temperature gradually to a normal level.
- If the massage chair is stored in a cold place and is being brought into a warm environment, it is advisable to wait one hour before use. This is because its performance may not be at optimum level, as there may be water droplets on the mechanical parts due to condensation. Using the massage chair under such conditions may result in malfunction.

IMPORTANT SAFETY INSTRUCTIONS

• Safety Precautions

- To ensure safe and correct use of the massage chair, do not operate it without reading this operation manual carefully.
- Do not use the massage chair when the upholstery or seat is removed. This may cause injury or malfunction.
- Do not use the massage chair in combination with other therapeutic equipment or electric blanket, etc., as this may result in ineffectiveness or injury.
- Do not use the massage chair an hour before or after eating as this may have adverse effects on the user.
- Do not allow children or pets to play around the massage chair, e.g., behind the backrest, under the seat or leg rest of the massage chair. This may result in injury.
- Do not rest or place heavy objects on the armrests, leg rest or backrest as this may result in malfunction or injury.
- Do not use the massage chair when your body is wet.
- Do not operate the massage chair with wet hands.

It is not recommended to use the massage for more than 15 minutes.

- Do not perform continuous massage on the same spot of your body for more than 5 minutes at a time as this may result in excessive stimulation and may have adverse effects.
- Do not insert your hand or foot along the paths of the massage rollers during use as this may cause injury.
- Stop operation immediately if you experience any discomfort.
- This product is not intended for self-treatment of conditions that should be managed by a qualified health care provider.
- People on medication or with medical conditions, please consult your doctor before use.

• People with Medical Conditions

Consult your doctor before use if you:

- are under medical rest as ordered by a doctor.
- have spinal disorders, an abnormal spinal condition or have suffered a spinal injury.
- have back problems.
- have diabetes, osteoporosis or sensory impairment.have joint dysfunction.
- have a pacemaker or other electronic medical devices.may be pregnant.
- have phlebitis or thrombosis.
- have an increased risk for blood clots.had recent surgery.
- have surgical pins, screws, or anything mechanical implanted in your body.

• Instances When the massage chair Should Not Be Used

In the following events, please switch off the main power switch immediately and disconnect the power cord from the electrical outlet:

- If water is accidentally spilled onto the massage chair. This may result in electric shock or malfunction.
- If the fabric of the backrest is torn and the internal components are exposed.
- If pain or discomfort is felt during massage, stop operation immediately and consult your doctor.
- If you detect any malfunction or any other abnormal condition during operation.
- If there is a power failure. Injury may occur when power is restored unexpectedly.
- If there is lightning.

• Assembly and Repair of the massage chair

- Do not disassemble the backrest cover of the massage chair. Touching the internal components may result in malfunction or electric shock.
- The massage chair must only be professionally serviced or repaired. Do not attempt to disassemble or repair the massage chair yourself.

• Things to Note About the Power Plug and Cord

- Check that the Alternating Current (AC) voltage corresponds with the specifications indicated for the massage chair.
- Do not connect or disconnect the power plug from the electrical outlet with wet hands. This may result in malfunction or electric shock.
- When disconnecting the power plug, pull it by holding the plug, not the cord.
- Although operation will be stopped automatically by the Auto-Timer function, always remember to switch off the main power switch after use. Do not place the power cord under the massage chair or any other heavy objects.
- Do not wind the power cord around the massage chair as this may damage the cord and result in a fire or electric shock.
- Do not operate the massage chair with a damaged cord or extension cord.
- Do not use the massage chair if the electrical outlet is loose.
- If the power cord is damaged, it should be replaced by a qualified technician.

• Grounding Instructions

This product must be grounded. If it is malfunction or breakdown, grounding provides a path of least resistance for electric current to reduce the risk of electric shock. This product is equipped with a cord having an equipment-grounding conductor and a grounding plug. The plug must be plugged into an appropriate outlet that is properly installed and grounded in accordance with all local codes and ordinances.

DANGER-Improper connection of the equipment-grounding conductor can result in a risk of electric shock. Check with a qualified electrician or serviceman if you are in doubt as to whether the product is properly grounded. Do not modify the plug provided with the product - if it will not fit the outlet, have a proper outlet installed by a qualified electrician.

This product is for use on a nominal 100-240V~ circuit and has a grounding plug that looks like the plug illustrated in sketch A as following illustration. Make sure that the product is connected to an outlet having the same configuration as the plug. No adapter should be used with this product.

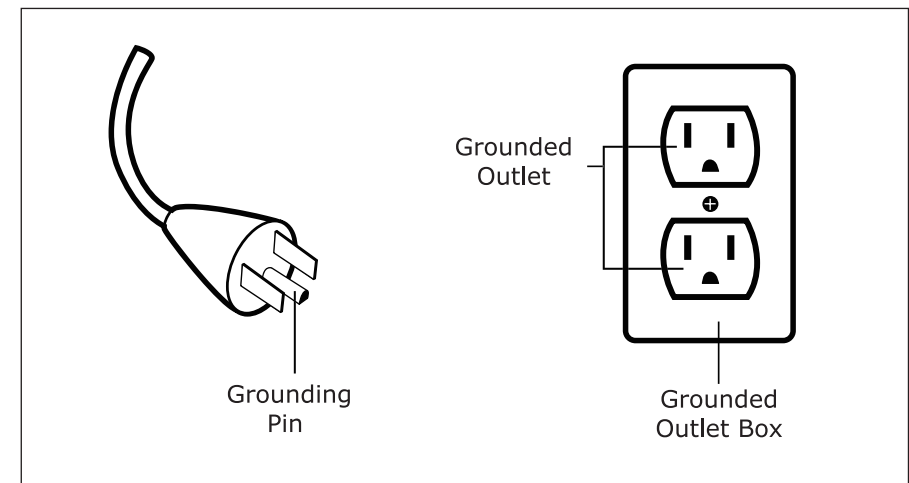

Components

Outer Structure

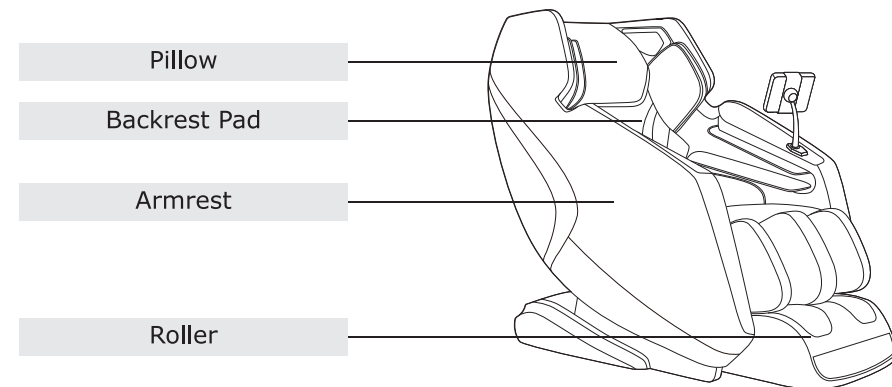
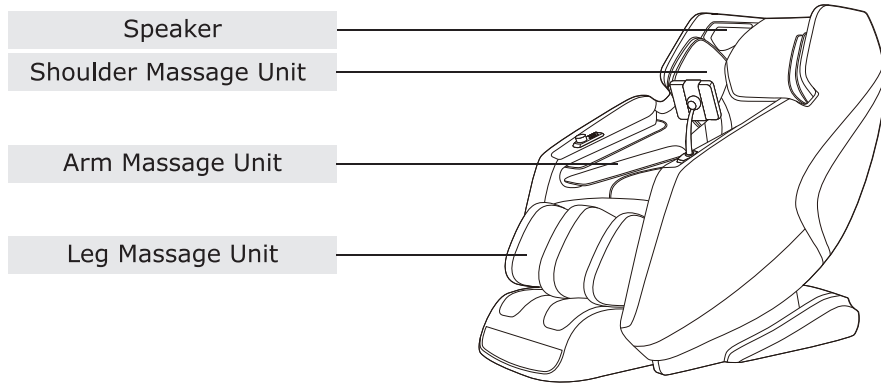

Intelligent Body Scanning

- When turning the chair on, it will start auto body scan measuring for the key areas of the back including your height. Please relax and lay your head down on the pillow.
- If you are not satisfied with the shoulder&neck detection, please press UP and DOWN to adjust manually, and press OK to confirm.

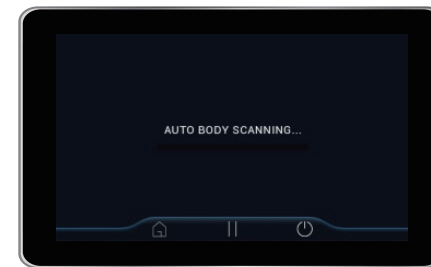

Functions



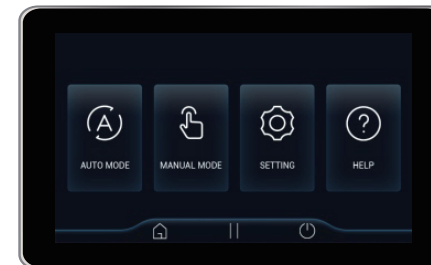



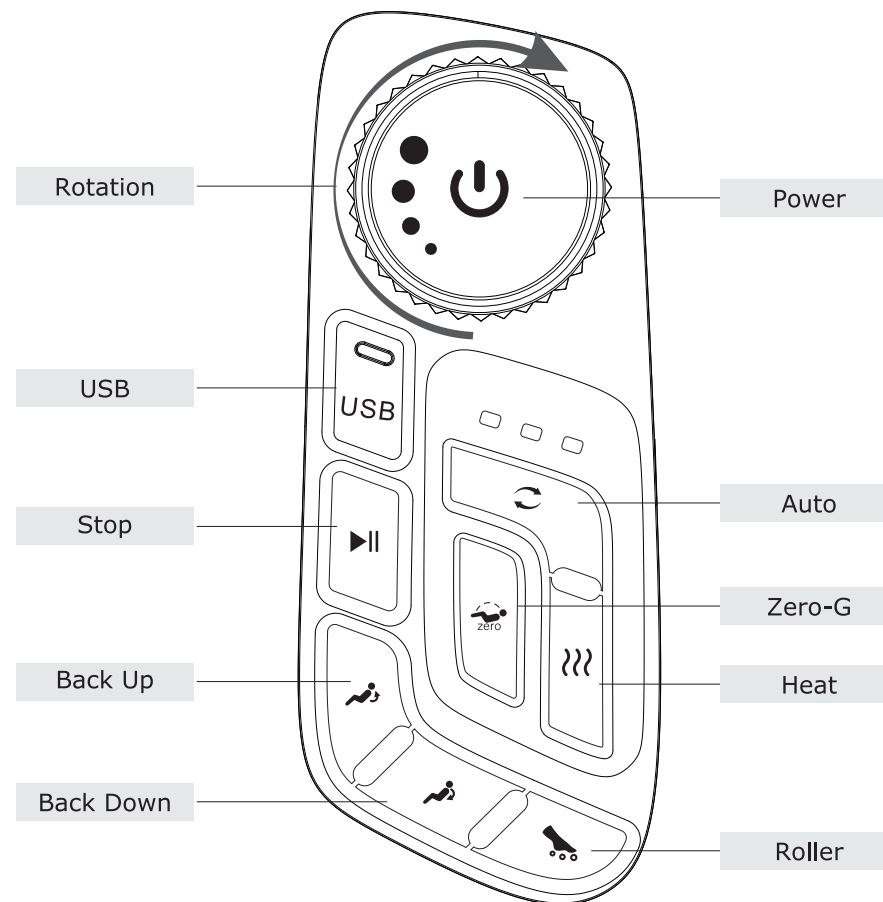

- You can choose the function according to your needs.
- You can check the Help (?) to know how to use.



Function	Description
Auto Mode	Choose a professional auto massage program , which is subject to the actual product.
Pro Mode	According to your own needs, you can choose a suitable massage technique for targeted massage, which can be generated as a proprietary program.
Memo Mode	Choose a favorite program for massage.
Setting	Go to the settings page and set the time, language, brightness, and sound.

Shortcut Key



Function	Button	Instruction
Power		ON/OFF
Rotation		Rotate clockwise to increase stage, and counterclockwise to decrease stages. The stage are divided into 1-5 stage.
Stop		Press this button to switch between multiple automatic program functions. The specific display is subject to the actual product.
Auto		Press this button to switch between multiple automatic program functions. The specific display is subject to the actual product.
Heat		Press this button to turn ON/OFF the heating function.
Zero-G		Press this button to turn off or switch the zero gravity of stage 1/2.
Back Up / Back Down		Press the Back Up/Down button to adjust the backrest angle.
Roller		Press the button to activate Roller, Press again to stop this function.

Preparation Before Use

Move the Chair

- Please turn off the main power and unplug the power from the electrical outlet.
- Tilt the chair backward as shown in the picture below and wheel it to the desired location.
- Please cover the floor with mat when move the massage chair in case that any damage of floor will be made.

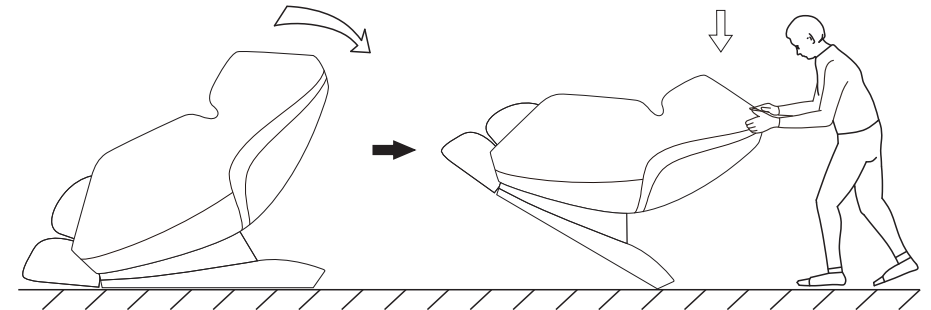

Site of Placement

Please make sure that there is an allowance of more than 2 inch behind the massage chair, and more than 14 inch in front of the massage chair to allow the backrest to recline without obstruction during operation.

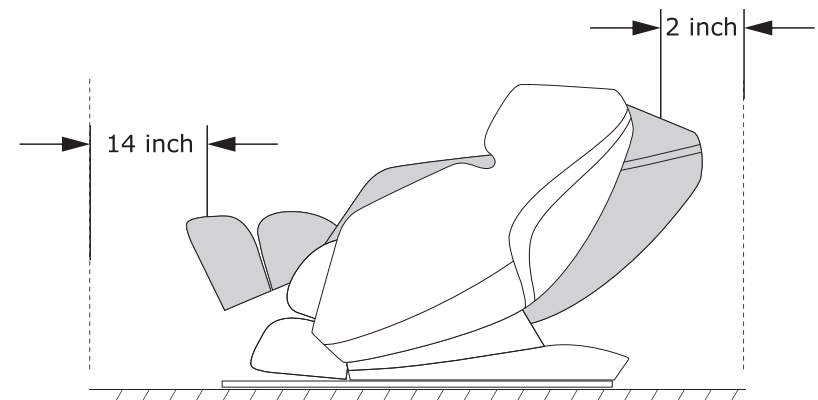

Place the Leg rest

- To prevent any damage from a sudden drop of the leg rest, please support the leg rest with both hands and gently put it down to its initial position.

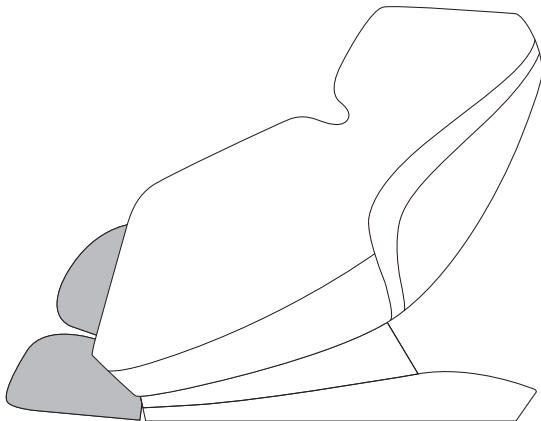
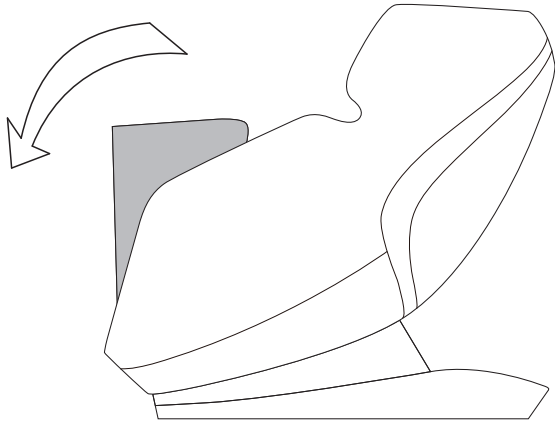

Install Backrest Pad and Pillow Pad

- Attach the upper backrest pad to backrest with zipper.
- Attach the pillow pad to backrest with Velcro.



- Attach the left side of backrest pad to backrest with zipper, same as the other side.

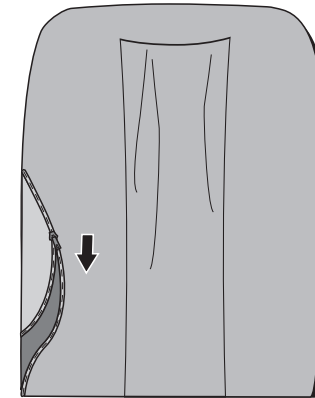

Installation of manual bracket

- Aligned holes, lock screw.
- Press down to align the snap.

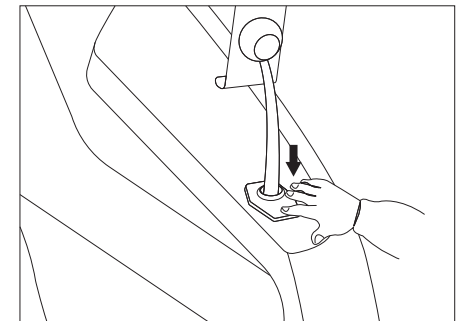
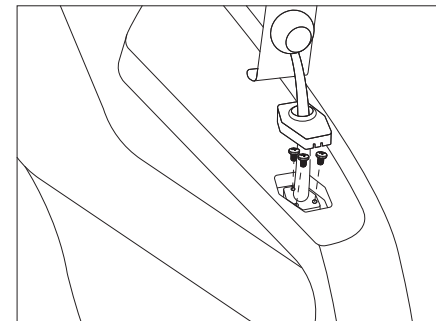

Remote Controller Connection

- Connect the cable of remote controller with the cable under seat.

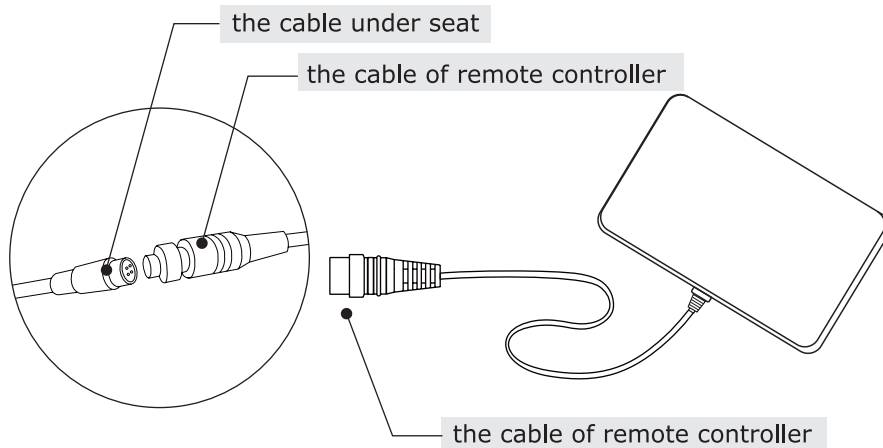

Connect power

- Plug the power cord into power inlet, turn on the power switch.

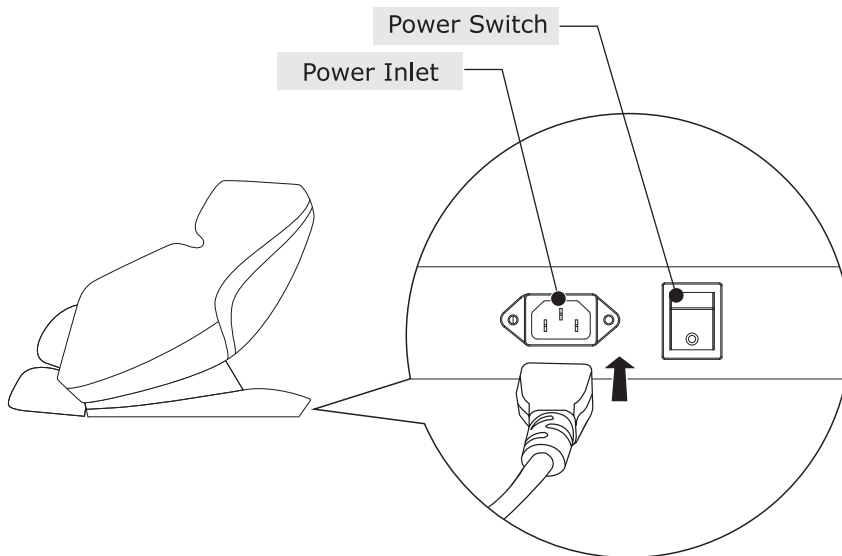

Cleaning and Maintenance

Maintenance methods

Please follow the below steps to clean leather and plastic parts

1. Please ensure the main switch is off and the power plug is unplugged from the electrical outlet.
2. Dip a soft, dry cloth in water or warm water containing 3% to 5% neutral detergent and wring it thoroughly.
3. Clean the leather and plastic parts.
4. Then wipe with dry soft cloth.
5. Let it dry naturally.

Warning

- Do not use alcohol, thinner, gasoline and other chemicals for cleaning.
- Do not dry the surface with a blower.
- Do not iron the fabric.
- During maintenance, always unplug the power plug. Do not unplug it by wet hands.
- Please use a dust cover to avoid dust if you won't use the chair for a long time.
- As fabric's color may be dyed on the leather, be careful when using denim and colored cloth to wipe the product.
- Wipe the product with the melamine foam dipped in mild detergent, if the dirt is hard to remove.
- Do not let the leather touch plastic in case of the color fading.
- Water temperature should not exceed 104 °F.

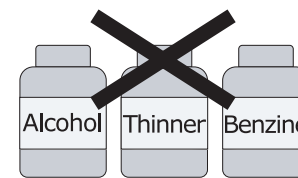

Please do not use



Water Temperature
<104 °F.

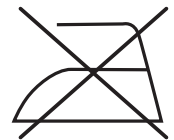

Do not iron

Troubleshooting

If there is still an abnormality after the following checks, to prevent any accident, please stop using the massage chair immediately. Please unplug the power cord from the outlet and contact with customer service center.

Problem	Possible cause/action
The massage rollers move up and then stop.	<p>In order not to affect the body, the automatic timer function will move the massage roller to the upper end when the massage is over .</p>
Noise during the massage	<p>Inevitable in structure, not abnormal</p> <ul style="list-style-type: none"> • The sound of clapping; • Friction sound of the massage wheel and fabric during kneading; • The sound of the massage wheel when lifting and kneading; • The sound during air pressure massage;; • The sound of the inflator pump; • The sound of airbag exhausting; • The sound of the backrest up and down.

Problem	Possible cause/action
The massage roller will stop during the massage.	<ul style="list-style-type: none"> •If the force applied to the massage rollers is too large, the massage rollers will stop running. •Lift your body slightly when using it, or raise the backrest slightly. (especially those who weigh more than 265lbs, please pay attention)
Press the power button, but the massage chair doesn't work properly or cannot connect to the power.	<ul style="list-style-type: none"> • Please check the following: <ol style="list-style-type: none"> 1. Is the power plug fully inserted into the socket? 2. Is the main power switch on the left rear of the unit turned on?
The power cord and plug are abnormally hot.	<ul style="list-style-type: none"> • Please stop using immediately.
Please contact with customer service.	
Do not disassemble or repair it yourself or by non-professionals.	

Specifications

Model	JL10013
Rated Voltage	100- 240V~
Rated Frequency	50-60Hz
Rated Power	170W
Upright Dimension	60x 30 x 44.5 inch (L x W x H)
Extended Dimension	64x 30x 37.5 inch (L x W x H)

