

# SuperFit

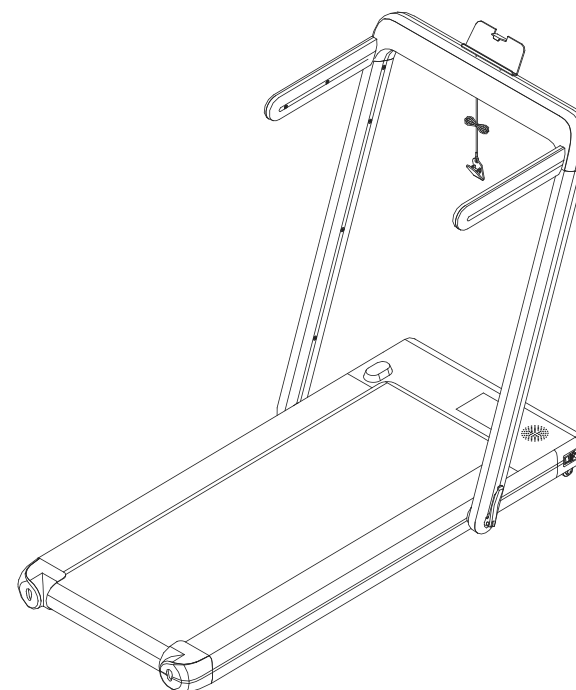

## USER'S MANUAL Treadmill

THIS INSTRUCTION BOOKLET CONTAINS **IMPORTANT** SAFETY INFORMATION. PLEASE READ AND KEEP FOR FUTURE REFERENCE.

**Please give us a chance to make it right and do better!**

Contact our friendly customer service department for help first.

Replacements for missing or damaged parts will be shipped ASAP!

**Follow Costway**



# Contact Us!

## Do NOT return this item.

Contact our friendly customer service department for help first.



# Before You Start

- ⚠ Please read all instructions carefully.
- ⚠ Retain instructions for future reference.
- ⚠ Separate and count all parts and hardware.
- ⚠ Read through each step carefully and follow the proper order.
- ⚠ We recommend that, where possible, all items are assembled near to the area in which they will be placed in use, to avoid moving the product unnecessarily once assembled.
- ⚠ Always place the product on a flat, steady and stable surface.
- ⚠ Keep all small parts and packaging materials for this product away from babies and children as they potentially pose a serious choking hazard.

# 1. Safety precautions Warning instructions

NOTE: Please read the instruction carefully before using and pay attention to the following safety precautions.

- ★ The treadmill is suitable to be placed indoors, to avoid moisture, splash water on the treadmill and place any foreign matter.
- ★ Please wear appropriate sportswear and sports shoes before exercise. Don't run barefoot on the treadmill. and keep stretching body.
- ★ The power plug must be connected reliably grounded, and the socket must have a dedicated circuit to avoid sharing with other electrical equipment.
- ★ Children should keep away from the machine to avoid accidents.
- ★ It is necessary to avoid overload operation for a long time. otherwise the motor and controller will be damaged. The bearing, running belt and running plate will be worn and aged. please keep regular maintenance.
- ★ Reduce indoor dust, maintain a certain indoor humidity, avoid strong static electricity, Otherwise it may interfere with the electronic meter. Keep controller normally working.
- ★ Please turn off the treadmill power after the use of sports.
- ★ Keep the clean and fresh air in the room when you use the treadmill
- ★ Please fasten the safety lock cable clip on the clothes when exercising in case of emergency.
- ★ Please stop exercising and consult your doctor if you feel uncomfortable and abnormal during using.
- ★ Please put silicone oil in a place out of the reach of children to avoid serious consequences caused by accidental ingestion after using the silicone oil.

## Warning: Please observe the following regulations in order to reduce accidents or injuries to others.

- ★ Please check your clothing or zipped before using the treadmill.
- ★ Don't wear clothes that can get caught on the treadmill.
- ★ Do not place the power cord near a hot object.
- ★ Keep children away from the treadmill.
- ★ Don't use the treadmill out of the door.
- ★ The power must be cut off before moving treadmill.
- ★ Non-professional personnel shall not open the upper guard cover and the left and right rear housing without authorization.
- ★ This treadmill can only be used in circuit of 15A.
- ★ Only one person can exercise on the treadmill when the machine starts.
- ★ Please stop exercising immediately and consult a fitness instructor when you feel dizziness, chest pain, nausea or shortness of breath during exercise.

## WARNING! ENFORCEMENT!

**Please be sure to discuss with a professional doctor before using if you are receiving medical treatment from a doctor or the following patient.**

- (1) Having back pain now or injury for leg, waist and neck in the past and the people who have problem with Leg (those with chronic diseases such as disc herniation, spondylolisthesis, cervical herniation)
- (2) Having deformed sex arthritis, rheumatism, gout.
- (3) Abnormal people with osteoporosis.
- (4) Having circulatory system obstacle (disease of heart, blood-vessel, hypertension)
- (5) Having difficulty in breathing.
- (6) Using artificial pacemakers or implantable medical electronic devices.
- (7) Having malignant tumors.
- (8) Having thrombosis or serious dynamic environment tumor, acute environment tumor and other blood circulation disorders or a variety of skin infections and other symptoms.
- (9) Having perceptual disabilities caused by diabetes and high peripheral circulation disorders.
- (10) Having skin injuries.
- (11) Having a high fever (38°C or above) due to illness and so on.
- (12) Having abnormal dorsal bones or crooked dorsal bones.
- (13) Having pregnancy or possible pregnancy or menstruation.
- (14) Feeling abnormal and have to rest
- (15) Poor physical condition obviously
- (16) Users for rehabilitation purposes.
- (17) Feeling uncomfortable in a certain region of the body except the above circumstances.  
—It's likely to cause accident or poor health.

◆ Please stop using immediately and consult your doctor when you feel pain in your back, numbness in your legs, dizziness, abnormal heartbeats and other body aches that are different from normal or poor coordination or other abnormal feelings during exercise.

◆ Do not allow children to use or play around the product.

—If not followed, there may be a risk of injury.

◆ Do not allow children to play with this product for child protectors.

—If not followed, there may be a risk of injury.

◆ Please make sure if there is person or pet around (rear, lower, front) during using or taking out product.

## Prohibition

◆ Do not use in the state of shell cracked, detached (internal structure exposed) or weld detached.

—Otherwise, it's easy to cause accident or injuries.

◆ Do not jump up or down during exercise.

—It's likely to fall or cause injury.

◆ Do not use or keep in damp places such as outdoors or near the bathroom, or in places where water drops are caught.

◆ Do not use or keep in places with direct sunlight such as high-temperature places of around the stove and heating appliances of electric heating carpets.

—Otherwise, it's easy to cause electricity leakage, fire.

◆ Do not use when the power cord or plug is damaged or the socket is loose.

—Otherwise, it's easy to cause electric shock, short circuit and fire.

◆ Do not damage or forcibly bend or twist the power cord. At the same time, do not place heavy objects on it, or not let the line be clamped.

—Otherwise, it's easy to cause fire or electric shock

◆ Do not use it with two or more people at the same time. Do not let the people around get close when using.

—Otherwise, it's easy to cause accident and injuries from falls.

◆ Do not use it if you can't express consciousness by yourself or operation.

—It's likely to occur accident or injury.

## Do not disassemble the treadmill.

◆ Disassembly, repair or re-election are strictly prohibited

—There is a risk of injury due to mechanical failure

## Avoid touching with water

◆ Do not spray water or other conductive liquid on main body or operation part.

—It may cause electric shock and fire.

## Prohibition

◆ People who don't usually exercise shouldn't suddenly do strenuous exercise.

◆ Do not use after eating or when you are tired. Especially after exercising or when you are in an abnormal physical state.

—It may cause damage to health.

◆ This product is suitable for the home use, do not use in the school, the gymnasium and so on or for non-specific users.

—There would be injury risk.

◆ Do not use when eating, drinking, or other activities.

◆ Do not use it after drinking until you feel sluggish.

—It's easy to cause accident or injury.

◆ Do not use it with something hard in your pants pocket.

—It's easy to cause accident or injury.

- ◆ Do not use the power plug with needles, garbage or water.  
——It may cause electric shock, short circuit and fire.
- ◆ Do not pull out the power plug or switch the power switch to “off” during use.  
——It may cause injury.

### Never use it with wet hands

- ◆ Do not pull out or insert the power plug with wet hands.  
——It’s likely to cause electric shock or injury

### Pull out the power plug

- ◆ Please pull out the power plug from socket when you don’t use it.  
——Dust and moisture make it insulation deterioration and lead to electricity leakage and fire.
- ◆ Please be sure to pull the power plug from the socket during maintenance.  
——Failure to comply may result in electric shock or injury.
- ◆ Please stop using it if the device does not start or runs abnormally. Immediately pull out the power plug and entrust inspection and repair.  
——Failure to comply may result in electric shock or injury.
- ◆ Pull out the power plug immediately in case of power failure.  
——Otherwise it’s likely to occur accidents or injuries when the power restored.
- ◆ Do not hold the cable tight. Hold the power plug to pull out the plug.  
——Otherwise, it may cause short circuit, electric shock and fire.

### Grounding instructions

- ◆ The product must be grounded. Grounding provides the channel with the least resistance to current to minimize the risk of electric shock if the function of this machine does not work normally.
- ◆ This product is equipped with a grounded conductor and a plug for the device. The plug must be properly installed, grounded and plugged into an appropriate electrical outlet in accordance with local codes or regulations.

### Dangerous

- ◆ There is a risk of electric shock if the device is not properly grounded. Please contact an electrician to check if the grounding of the product is correct, if the plug does not fit into the socket it can not be changed. Please inform a qualified electrician with the installation of a suitable socket.
- ◆ This product has a grounding plug. Make sure that the product is connected to an outlet of the same shape. this product can not be used with an adapter socket.

## 2、Exploded-Views

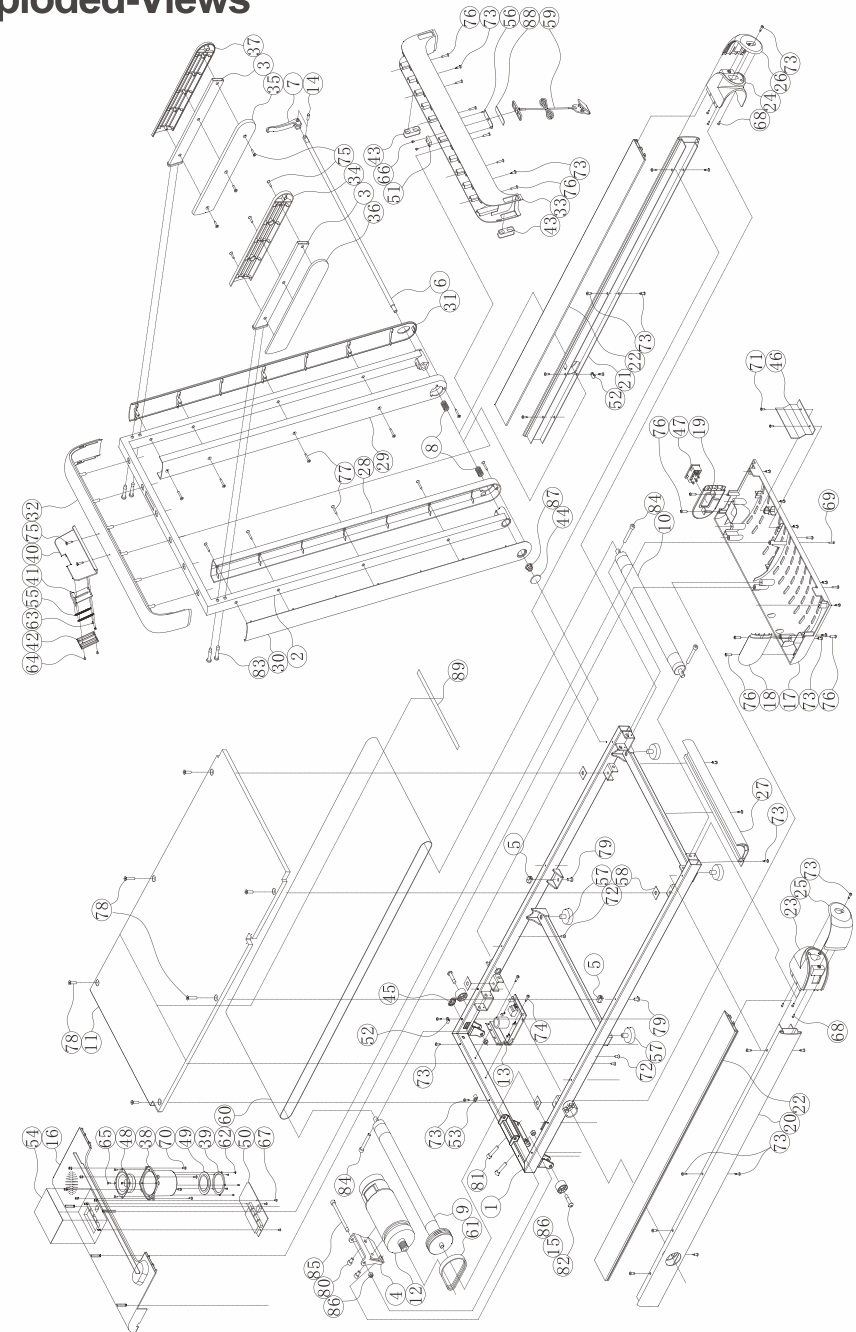



### 3、Details of Exploded-Views

NO.	Name	Qty.	NO.	Name	Qty.
1	Main frame welding parts	1	47	Power switch2.0	1
2	Riser welding parts	1	48	Horn	1
3	Handlebar welding parts	2	49	Bass membrane	1
4	Motor fixed housing	1	50	PCB panel	1
5	Ling shaped cushion	2	51	Sense block	1
6	Pull rod	1	52	3.2 wire clipper	2
7	Folding handle	1	53	6.4 wire clipper	1
8	Press spring	2	54	sticker on electronic meter	1
9	Front roller	1	55	Phone bracket pull spring	2
10	Rear roller	1	56	Safety lock flap	1
11	Running board	1	57	Adjustable feet pad	4
12	Motor	1	58	Running board EVA pad	4
13	Controller	1	59	Safety lock assembly parts	1
14	Rivet	1	60	Running belt	1
15	Moving wheels	2	61	Poly V-belt	1
16	Up protect cover	1	62	STF 2.2*4.5 bolts	5
17	Down protect cover	1	63	STF 2.2*8 bolts	2
18	Left side cover of protector	1	64	STF2.6*8 bolts	2
19	Right side cover of protector	1	65	STF2.6*9.5 bolts	4
20	Left tube	1	66	STF2.9*4.5 bolts	2
21	Right tube	1	67	STF2.9*6.5 bolts	3
22	Tube	2	68	STF2.9*9.5 bolts	6
23	Left tail housing	1	69	ST2.9*19 bolts	1
24	Right tail housing	1	70	STF3.3*9.5 bolts	4
25	Left tail housing cover	1	71	ST3.5*13 bolts	2
26	Right tail housing cover	1	72	ST4.2*16 bolts	6
27	Tail trim	1	73	ST4.2*16 bolts	31
28	Inner cover of left riser	1	74	ST4.2**19 bolts	2
29	Inner cover of right riser	1	75	ST4.2*22 bolts	8
30	Outer cover of left riser	1	76	ST4.2*22 bolts	13
31	Outer cover of right riser	1	77	ST4.2*30 bolts	10
32	Up cover of electronic meter	1	78	M8*25 bolts	6
33	Down cover of electronic meter	1	79	M8*10 bolts	2
34	Inner cover on left handle	1	80	M8*12 bolts	2
35	Inner cover on right handle	1	81	M8*35 bolts	2
36	Outer cover on left handle	1	82	M8*35-10 bolts	2
37	Outer cover on right handle	1	83	M8*45-10 bolts	4
38	Speaker shell	1	84	M8*55 bolts	3
39	Bass film fixer	1	85	M8*105-10 bolts	1
40	Phone bracket panel	1	86	M8 screws	3
41	Phone bracket splint	1	87	M10 screws	1
42	Phone bracket back panel	1	88	Safety lock sticker	1
43	Riser square plug	4	89	EVA single-sided adhesive tape	1
44	Riser round plug	1			
45	Square spacer	1			
46	Anti-dust board	1			

### 4、Product introductions

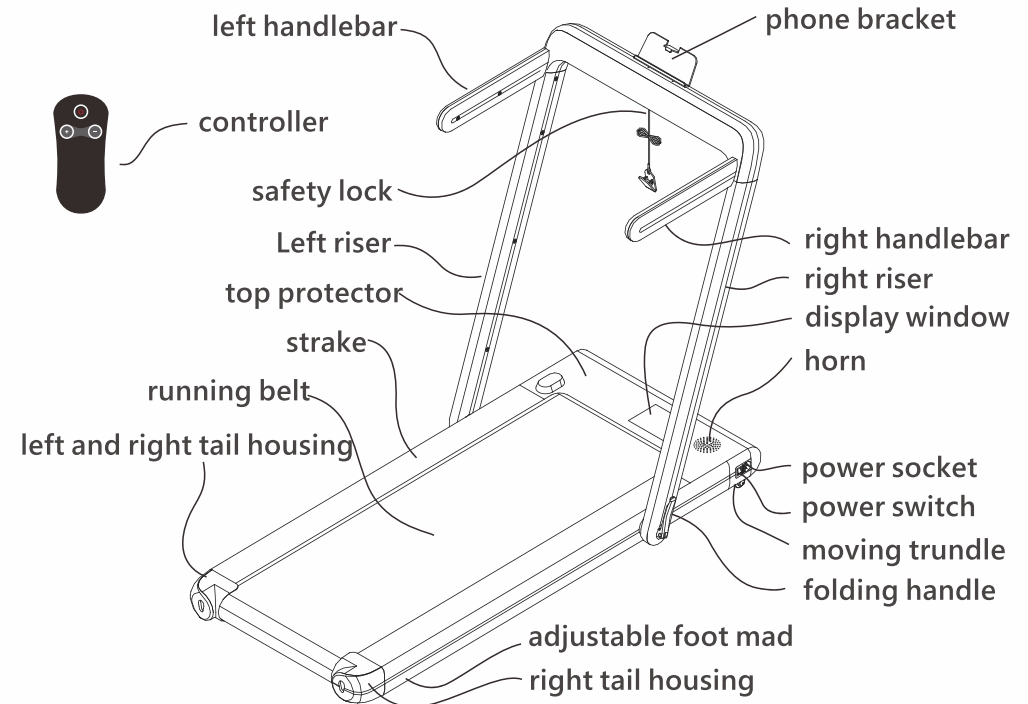

packing list:

No.	Name	Qty.	Remark
1	Main body	1	
2	Left handlebar	1	
3	Right handlebar	1	
4	Spare parts package	1	See table

Technical Parameters

Working voltage	AC-110V 60Hz
Max load	265 lbs
outsized	Fold: 52*27*5 inch
	unfold: 49*27*42 inch
running area	40*16 inch
Peak motor power	2.25HP
speed	0.6-7.5 mph
control method	controller
weight	74 lbs
Function	walking pattern running pattern

Spare parts list

NO.	Name	Qty.	Remark
1	ST4.2*22 bolts	2	fix phone bracket
2	M8*45 bolts	4	fix left and right
3	5mm internal hexagonal wrench	1	others
4	6mm internal hexagonal wrench	1	adjust running belt
5	open wrench	1	others
6	15mm socket wrench	1	Folding handle force adjustment
7	power wire	1	
8	safety lock	1	
9	methyl silicone oil	2	
10	phone bracket	1	
11	controller	1	
12	manual ,Qualification certification	1	

5. Installation procedure

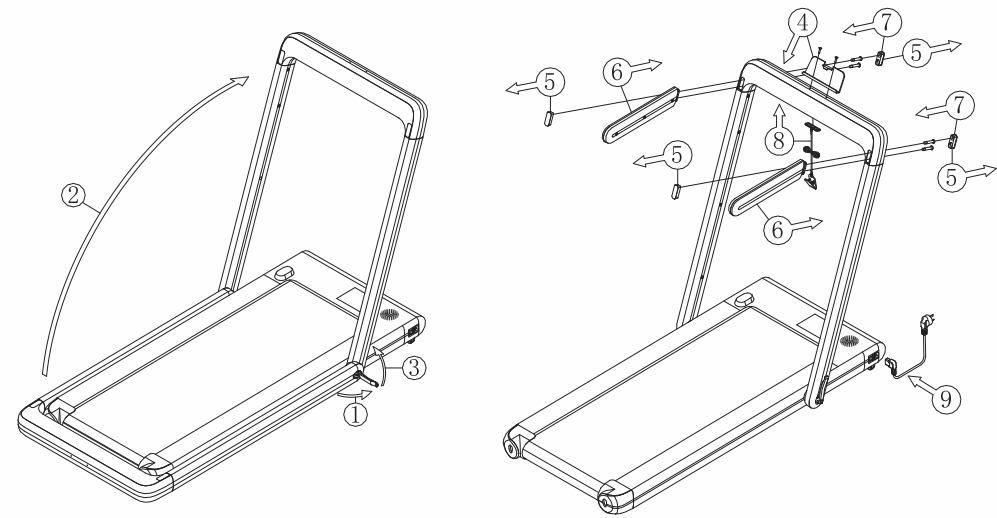

Put the main body on the carpet or cushion as shown in the picture after taking out from packing carton.

As shown in the step1 of the left picture. Open the folding handle in the direction shown in the picture. meanwhile the lower end of the riser will naturally expand to the two sides. Raise the riser upward to the upper limit position as shown in the step2 of the left picture. Press “folding handle” and locked riser as shown in the step3 of the left picture.

Fix “phone bracket” with two pieces ST4.2\*22 bolts on riser beam as shown in the step4 of right picture. Cutout 4pieces “square rubber plugs” as shown in the step5 of right picture. insert left and right handlebar into the corresponding positions and lock them into the corresponding screw holes of the handlebar through the riser with two pieces M8\*45 bolts. Put 2pieces “square rubber plugs” back into the previous square hole. And keep the remaining two pieces by yourself as shown in the step of 7 of right picture.

Put the “safety lock” into the corresponding position under the beam of the riser as shown in the step 8 of right picture. Insert the power cord into the socket of the power switch and install it.

Note: Please check again whether all bolts are locked after the assembly of this machine.

## 6. Method for replacing fuse

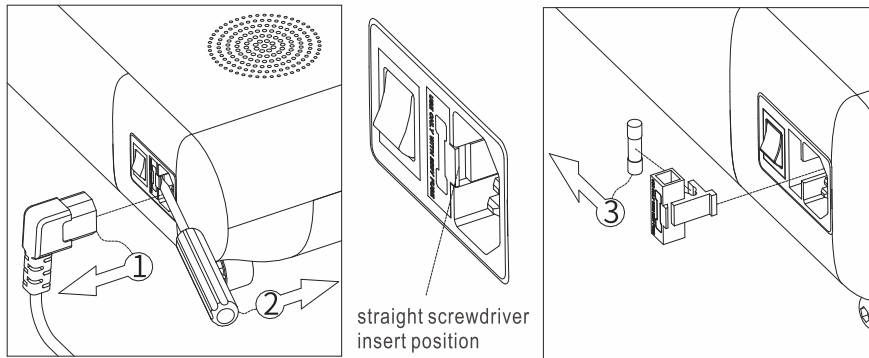

Pull out the power plug from power socket as shown in the step1 of left picture. Remove the safety socket from the power socket with a straight screwdriver as shown in the step2 of left picture. Take out the fuse according to the direction shown in the picture, and insert it after replacing it.

Note: the machine fuse insurance tube specifications for 125V/15A  $\Phi$ 5\*20mm

## 7. Folding handle strength adjustment

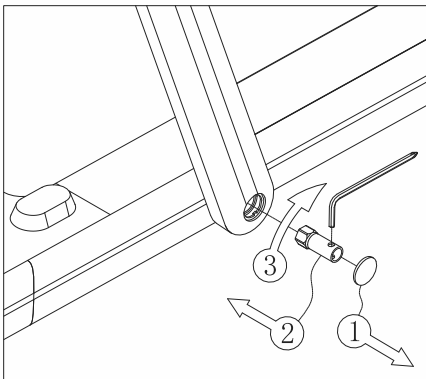

The machine was set to a slightly more suitable level of tension when finishing production, but due to the different personal wrist strength, users can adjust the folding handle properly to their own taste. Do not put it too loose. a loose play leads to a large distance between the riser and the host of the folding position, producing a jarring phenomenon, cut out the round rubber stopper at the bottom of the riser, as shown in box 1 above. Combine the Allen key and the socket wrench to a labor-saving one levers, as shown in the oblique branches. insert the Allen key into the lower end hole of the left riser and secure the hex nut. Rotation in the clock means fast. otherwise it is a bit too loose.

## 8. Sports advice and guidelines

### warm-up exercise

warm up for 5-10mins before each operation

### Breathe

Do not hold your breath during operation. Normally prepare to release action and inhale through the nose, exhale through the mouth. The breathing should be coordinated with movement. If the breathing is too rapid, the movement should be stopped immediately.

### Frequency

The exercise of the same muscle should keep 48hours of rest. That is , only train the same area every other day.

### Load

Determine the amount of training according to the individual physical condition, and then practice according to asymptotic load. It is normal phenomenon for muscle soreness at the beginning of training. As long as continue to practice the soreness can be eliminated.

### Relax

The reductive action should be done for 5mins after practicing every time. Especially extend flabby for ministry muscle. avoid muscle long-term condensation, and keep muscle flexibility.

### Diet

Do not eat at least 1 hour before training and half an hour after training to protect your digest system. Avoid drinking plenty of water to avoid increasing burden of heart and kidney.

### Stretching exercise

It is important to stretch before training, no matter how intense the training will be. It is easier to stretch the muscles when they are warm. warm up by running for 5 to 10 minutes and then stop and stretch as follows 5 times for 10 seconds or more on each leg. continue to stretch even after training. Do it again after you work out.

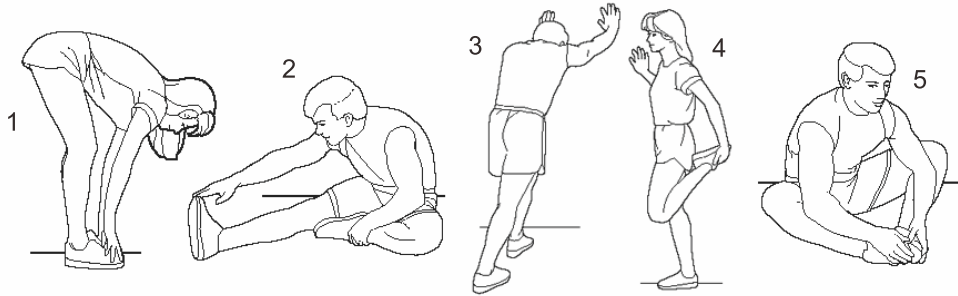

**1. Stretch down**

Bent your knees slightly and slowly bend your body to relax your back and shoulders. And try to touch your toes with your hands. Hold for 10-15 seconds, then relax. Repeat three times (see figure 1)

**2. Hamstring stretch**

Sit on a clean seat cushion and straighten one leg. Bring the other leg in close to the inside of the leg. Try to touch your toes with your hands. Hold for 10-15 seconds, then relax. Repeat with each leg three times (see figure 2)

**3. Stretch the calf and hamstring**

Stand with two hands on a wall or tree. One foot is behind. Keep your hind legs straight and on your heels, leaning against a wall or tree. Hold for 10-15 seconds. And then relax. Repeat 3 times for each leg. (see figure 3)

**4. Quadriceps stretch**

Keep balance with left hand to hold the wall or table. Then extend your right hand backward. Hold your right ankle and slowly pulling toward your hips until you feel tension in front of your thighs muscles. Hold for 10-15 seconds, then relax. Repeat 3 times with each leg (see figure 4)

**5. Sartorius muscle (muscle of the inner thigh) stretch**

Sit with your feet facing each other and knees facing out. Grab both feet with both hands and put toward the groin. Hold for 10-15 seconds. Then relax, repeat 3 times (see figure 5)

**9. Operating Instructions**

**The remote control and treadmill pairing instructions**

1. Turn on the power and check if the machine work normally.
2. Hold the remote control and aim it at the display window of the treadmill (as shown in FIG. 2) within 10 seconds after unplug the treadmill security lock (as shown in FIG. 1). Meanwhile, press the start/pause button on the remote control for about 3 seconds, and the system will sounds "didi... ", indicating that the remote control and treadmill have been successfully paired, and the remote control can be used to control the treadmill normally.

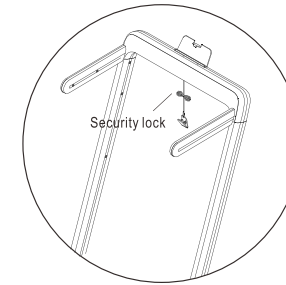

figure 1



Display window

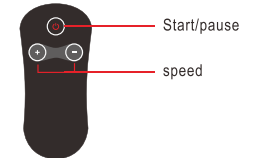

figure 2

**How to use the treadmill**

1. Power on, check and confirm if the machine work.
2. This machine is set with walking mode and running mode. When the riser is folded (the riser is parallel to the the running platform) It is the walking mode. In the walking mode, the speed of the running belt is 0.6-3.0mph. Remove the left and right handlebar and plug the square rubber stopper when using the walking mode. It is in the running model when the riser is in the expansion state. In the running mode, the speed of running belt is 0.6-7.5mph
3. The safety lock should be clipped on the lapel of the athlete's chest.
4. It is necessary to check the stability and function of the treadmill before exercise. It is strictly prohibited to start the treadmill by standing on the running belt. You should stand on the side strip and hold the handlebar and remote control before operation, start to run after normally work. One hand grab handlebar, the other hand hold remote control key when power on (●), treadmill starts up in a delay of 3 seconds and runs at a speed of 0.6mph. Press "+" and motor speed will rise to reach a speed of 1.5-2.2mph (This is the most comfortable speed for learning running). Hold the handlebar with both hands and step on the running belt with both feet successively which will reach the same speed with the running belt soon.
5. You can increase the speed of running after a few minutes. Press the "+" button on the remote control to increase the speed slowly. You can also press the "-" key to slow it down.
6. In the process of movement, you can press the "●" key of the remote control at any time to make the motor stop running.

7. You can hold the phone in the phone holder and then play the phone music after connecting via Bluetooth.

**Note: When the safety key is pulled off, the treadmill will immediately stop during exercise.**

**The display will stop all functions and shows E07.**

**Description of the display and the remote control button.**



1、LED window displays the following functions :

Time/speed/distance/calorie window: 5 seconds switch display time, speed, distance and calorie data,  
 time display range:0:00-99:59, distance display range:0.00-99.99.  
 speed display range 0.6-7.5, Calorie display range:0.00-999.9

2、Remote control function key: start/stop, speed+ speed-

- A. Start/stop: Press this key to start the motor in the stop state. Press this key to slow down and stop in the running state.
- B. Speed- This key will slow down the speed during exercise.
- C. Speed+ this key will increase the speed during exercise.

**Start instructions**

- 1、 Fix the safety key in the position provided under the display. Turn the power switch on and the buzzer will sound then the manual mode will be activated.
- 2、 Press the start button, the time window displays a countdown of 3 seconds. Every second a beep sounds, which signals the countdown. The motor then start.
- 3、 Starting speed :0.6mph press speed + and - to adjust the speed.
- 4、 The time is timed operation in normal mode state, speed is fixed and can be adjusted manually.

**Safety lock function**

Pull off the safety lock in any state,window display “E07” And the buzzer bi-bi-bi three times. The motor is stopped immediately if the motor is working. You can't start again when the safety lock falls off.

**Power saving mode**

This system has the function of power saving. The system will enter the mode of power saving if there is no keystroke command within 10mins in the standby state, display automatically turn off, It can be woken up when any key is pressed.

**10、Common failures and processing method**

please call our dealer or our after-sales service if you have any other questions

questions	Possible causes	maintenance methods
treadmill don't work	not connected	put plug to insert socket
	Power is not turned on	Put the power switch in position"NO"
	safety lock drop	put the safety lock in correct position
	circuit signal system break	check the controller input terminal and signal circuit
the running belt doesn't run smoothly	the fuse blew out	replace fuse
	insufficient lubrication	add silicone oil lubricant
running belt slipped	Belt is too tight	adjust belt tightness
	running belt too loose	adjust running belt tightness
	running belt too tight	adjust running belt tightness

**Error messages on electronic meter and elimination methods**

questions	possible cause	maintenance methods
E01	poor communication	The signal line is not plugged it. Plug it again
E02	power assault	power tube breakdown, replacement of electronic control
E03	Non-sensing signal	sensing wire is not plugged in properly. Plug it again correctly
E04	controller or motor abnormal	overload, replace controller or motor
E05	overload protect	overload, replace controller
E06	system self-check failed	system failure, replace controller
E07	safety lock drop	put the safety lock in correct position
abnormal display	external disturbance	turn off power switch, turn on it after one minute



## 11、Product maintenance

### 1、lubrication

The running is used for a period of time, it must be lubricated with special methy silicone oil.

#### Advice:

- ★ 1 hour or less per week                      lubricate once every 6 months
- ★ Less than 3 hours per week                lubricate once every 3 months
- ★ 3-6 hours per week                            lubricate once every 2 months
- More than 6 hours per week    lubricate once a month

Do not lubricate too much. It is not the more lubricants the better.

Remember: Proper lubrication is an important factor in improving the life of the treadmill.

### 2、As for the way to check if you need to add lubricant.

**Just grab the running belt and touch the middle of the running belt back with your hands as much as possible. You don't need to add lubricant if you have silicone on your hand (a little damp) You have to add lubricant if the pad is dry and there is no silicone on your hand.**

- ★ the step of lubricate on the running plate (as shown right picture)
- ★ Stop running for and fold the machine.
- ★ Lift the running belt of the underside of the main body,Put the oil pot as far as possible into the middle of the running belt. And spray methyl silicone oil inside of the running and both sides.
- ★ You can make use of the treadmill speed of 1km/h to evenly lubricate and step on the running belt from left to right. After a few minutes, the methyl silicone oil can be completely absorbed by the running belt.

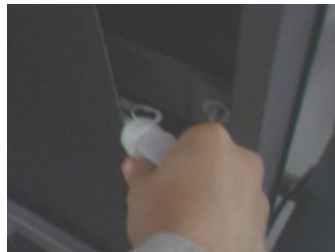

**3、Adjust tightness of running belt, All treadmills shall be adjusted for tightness before delivery and after installation. However, the running belt may be loosened after a period of use. For example,The treadmill had stopping and slipping question during exercise.Adjust bolts of running belt with the left and right synchronous as per clockwise direction to half a circle as the unit when this phenomenon occurs.The feet will slip if the running belt is too loose. But it is not good to be too tight. It is easy to increase the load of the motor and damage the motor,running belt and roller etc.**

### 4、Running belt deviation adjustment

All treadmills need to be adjusted the running belt before delivery and after installation.But the running belt may be deviated after a period of use which may be caused by the following reasons.

- ① The main body is not placed smoothly.
- ② The feet of users are not in the center of the running belt.
- ③ The feet of users are uneven force

**It will be returned to normal after a few minutes of no-load rotation if deviation is caused by man-made.It should be adjusted with 6mm wrench at a half circle as the unit for deviation of non-recover automatically.**

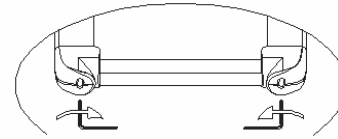

Please adjust left bolt with clockwise or right bolt with counterclockwise if running belt is left deviation.

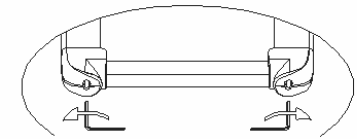

Please adjust right bolt with clockwise or left bolt with counterclockwise if running belt is right deviation.

The running belt deviation is not within the scope of warranty. And it is mainly maintained by the user according to the manual. Running belt deviation will seriously damage the running belt. The mistake must be found in time and corrected.

### 5、Adjustment of motor belt (as shown in the right picture)

All treadmills have been adjusted for the motor belt before and after installation, but they may still be out after a period of use. Now the phenomenon of loose slip, mainly by the user to adjust.

#### Adjustment steps:

- ① Adjust the parallelism of the motor with a wrench Turn the bolt half a turn counterclockwise.
- ② Turn the belt tightening bolts clockwise Half a circle.

NOTE: clean belt and pulley grooves regularly.

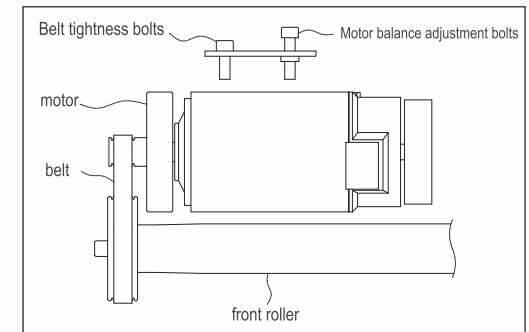

## 12、Service commitment

Electric treadmill, If no-human damage, can be free for users to come to repair or provide accessories in one year use normal circumstances. After the warranty period can be appropriate to provide free labor maintenance cost. Spare parts prices from preferential. Please refer to the warranty card for details.

### Important information

The warranty card of this machine comes with each product. Which is filled by the dealer. Free replacement parts within the warranty period. Such as incorrect installation,incorrect use or replace facilities caused by the fault, our company will not be responsible for them. In addition, this warranty card is not applicable to people who do not have the authorization of the company for maintenance.The customer afford this cost by himself if resulting maintenance costs like this.The user must issue the invoice when maintaining. The guarantee is invalid if there are not any bill or guarantee card.This product is only for home use. We are not responsible for any problems caused by commercial use. Please call our dealers or our after sales service if your products need maintenance service.



# Gymax App Instruction Manual v1.0.2

This document is applicable to the Android version and iOS version of the official APP of Gymax.

**iOS: Search Gymax in App Store to download**

**Android: search and download from Google Play store**

## Functions Overview

Gymax App iOS/Android with Gymax platform provides users the control of sports intelligent device, sports data recording, sports mall, dynamic sharing in community, system Settings and other functions.

## The Main functions

- > Sign In
- > Sports Scenes
- > Sports Mall
- > Community Dynamic
- > Settings

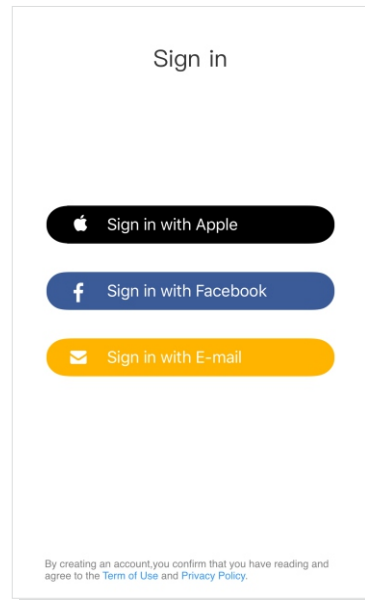

## Sign in Process

**Sign in**  
For the convenience of users, Gymax provides three login methods: Facebook and E-mail, and iOS users can also Sign in with Apple. Users can quickly sign in to the Gymax App and use it.

## Retrieve Password

If E-mail users forget Passwords, users can click "Forget Password" on the mailbox login interface to jump to the Password retrieval interface, and then reset Passwords.

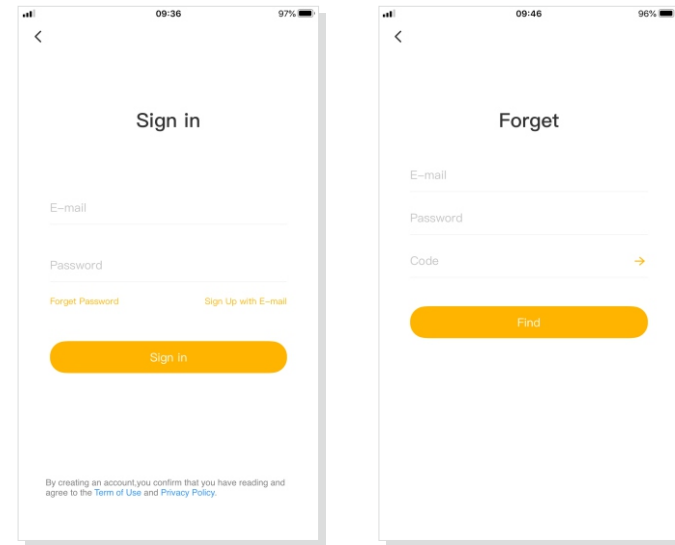

## Edit Information

In the personal information interface, clicking the avatar, users can edit the avatar and upload the avatar by choosing album or camera.

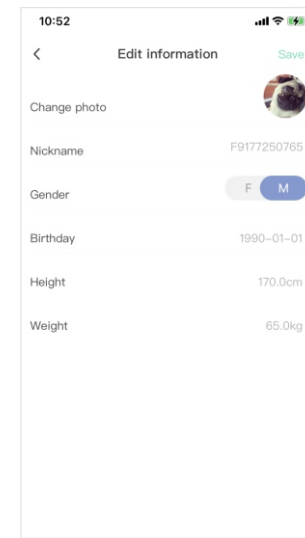

**Sports Scenes**

Connecting services

On the home page, users can freely choose the device type to connect. After connecting successfully, users then start the device page, such as the "Treadmill" interface.

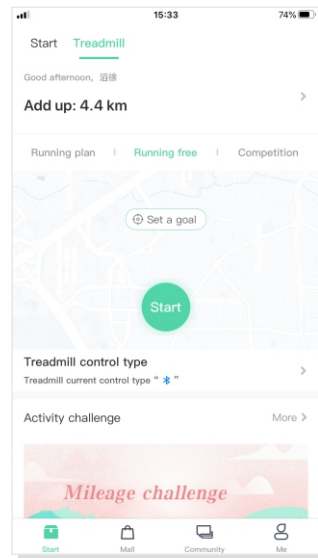
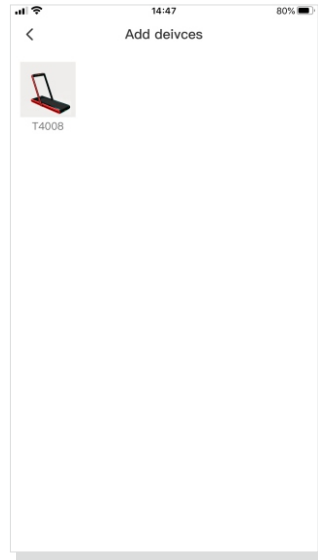
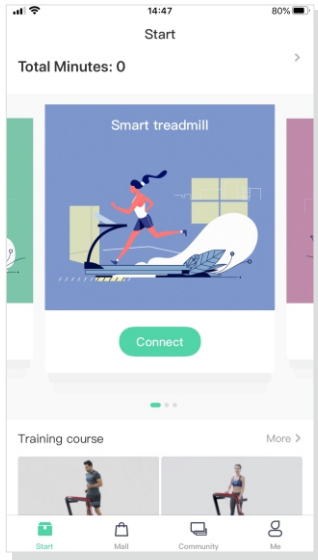



**Starting exercise**

Selecting the device page, such as "Start" on the "Treadmill" interface, users enter the running free, as shown below:

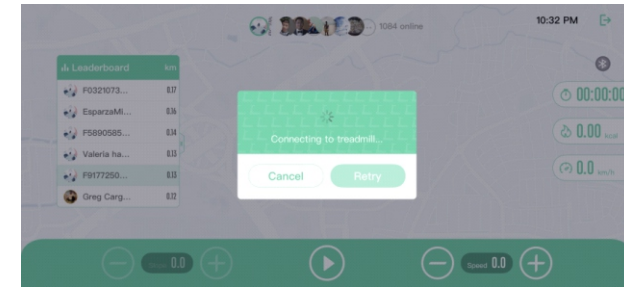
1. Waiting for GyMax to automatically connect to the treadmill.



2. When the connection status sign  is lit, it means that the APP has successfully connected to the treadmill. Users click , then the treadmill start Running and enter the countdown. 3.2.1 GO.

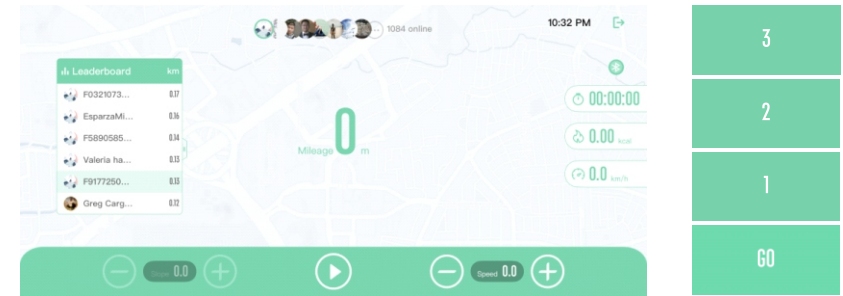

3. The GyMax App synchronizes exercise data, such as mileage, duration, calories, and speed, as users run on the treadmill, and users can start or stop, accelerate or decelerate the treadmill, which intuitively shows users' current sports ranking and the number of online sports in real time.



4. When users finish the exercise, the Gymax App will show users' total mileage.

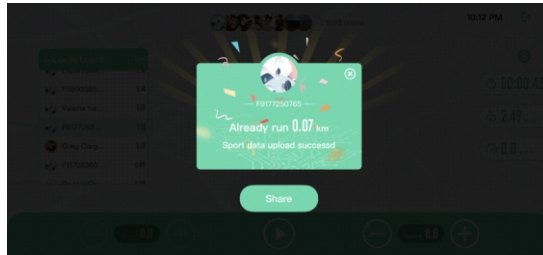

5. Users can share the sports data to the community or save it to the phone album.

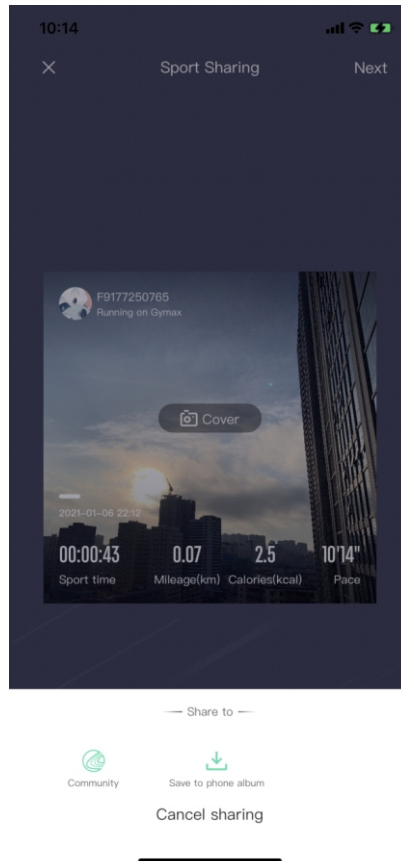

## Sports Plan

Users can click "Add More Training Plans" to Add users' own sports plans.

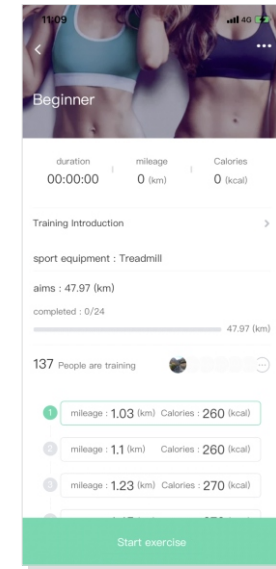
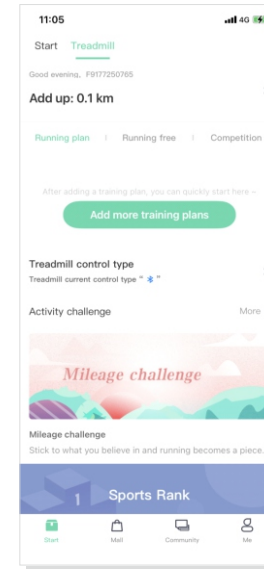

## Setting Goals

1. Users can set suitable sports goals.

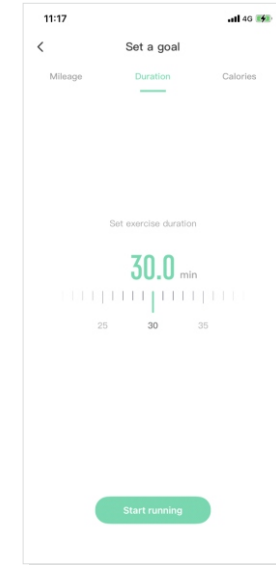
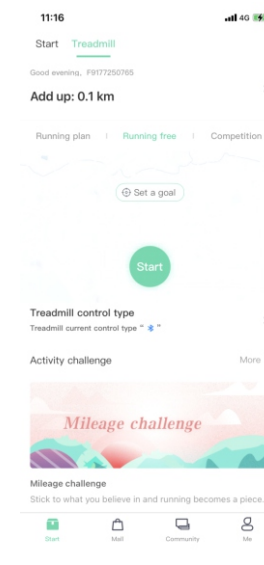

2. When the goal is reached, the exercise automatically ends.

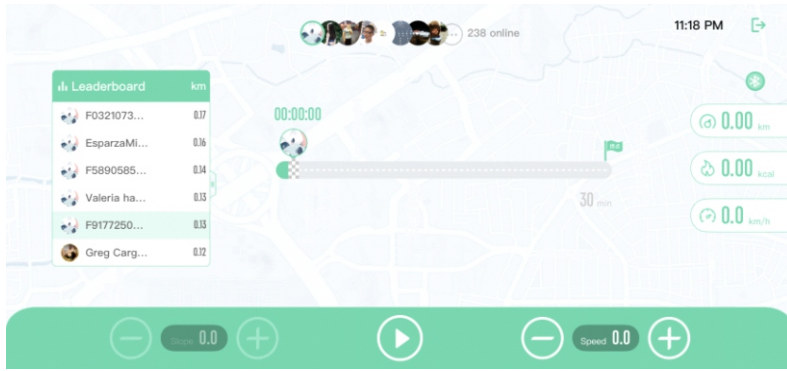

## Training Course

1. Users can select courses in the interface of training course.

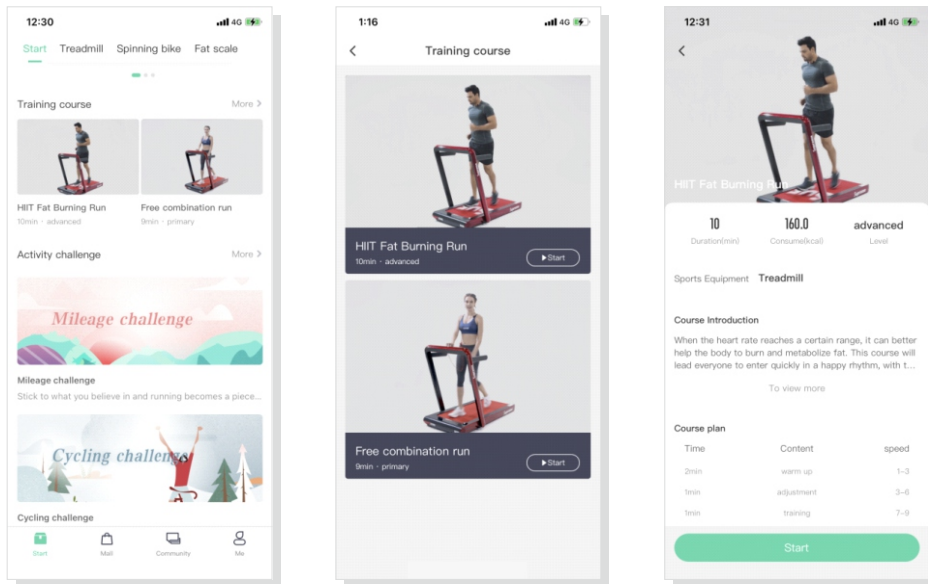

2. And then Start training with a fitness coach.

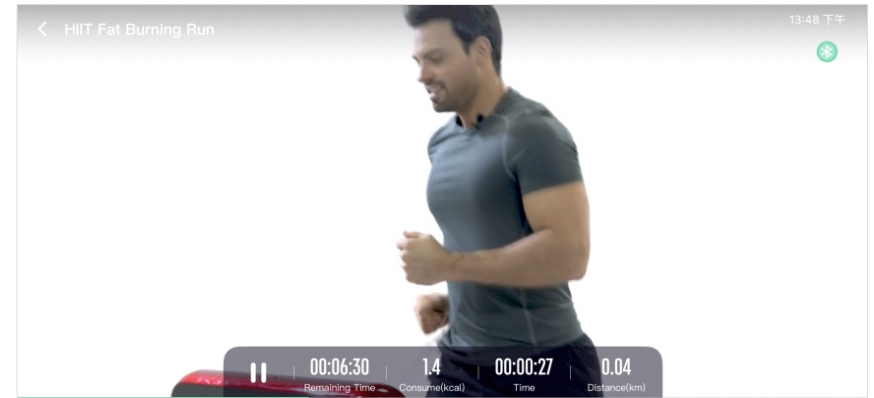

## Exercise Record

The user can view the Exercise data record in the device page. (me-exercise data)

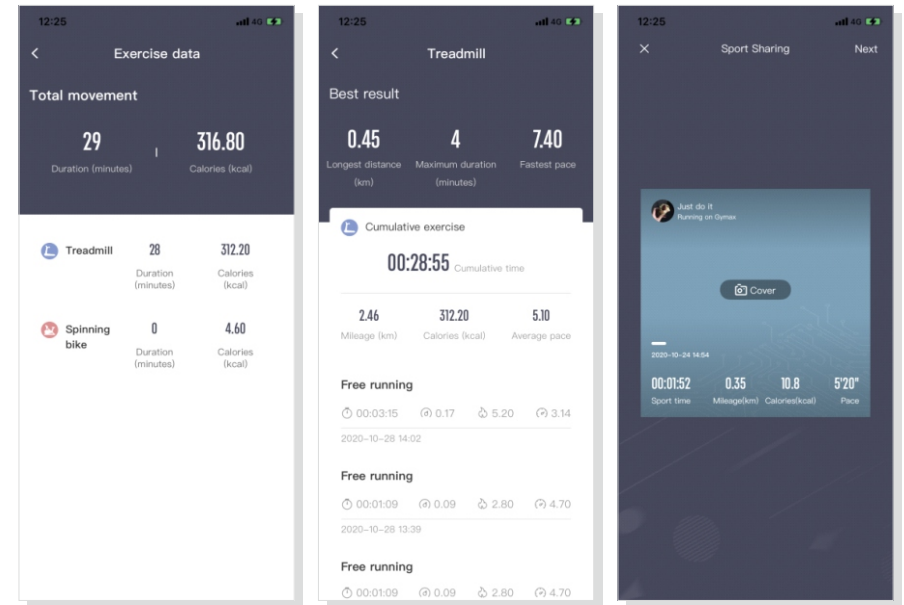



**Sports Mall**

Users can purchase satisfied sports devices.

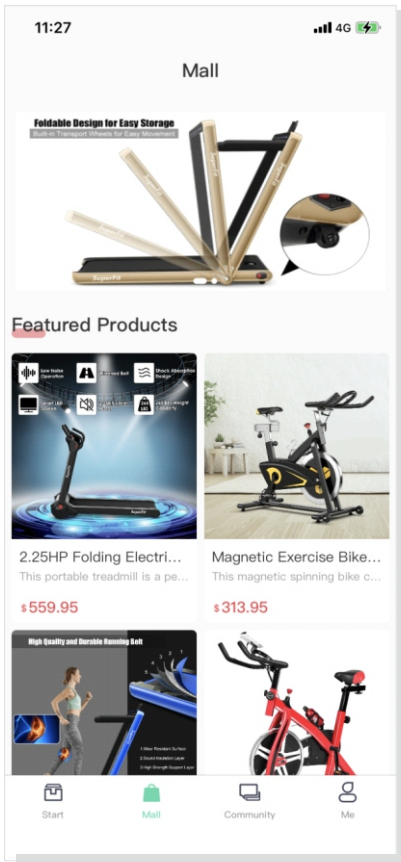

**Community dynamic**

1. In sports community, users can share dynamic communication with each other.

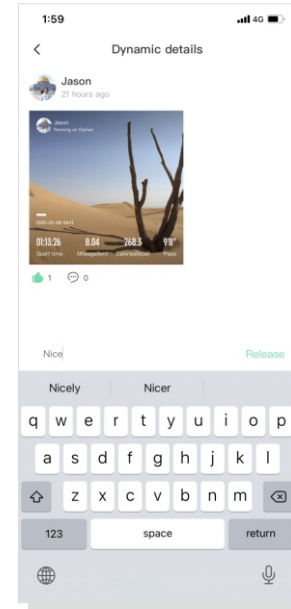
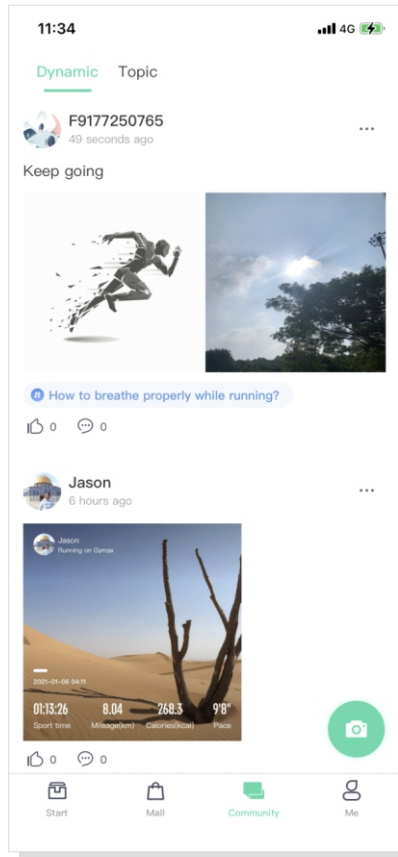

2. Users can comment dynamics in community.

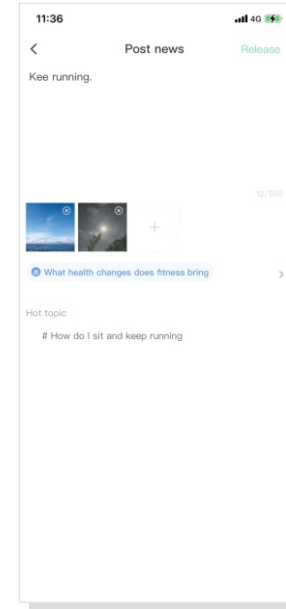

3. Users can post dynamics.

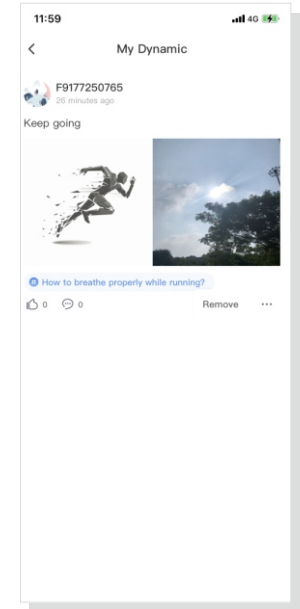

4. Users can remove the released dynamics in Me-My Dynamic.

**Settings**

**System Settings**

Users can click "Me" to enter the set up, including unit, feedback, terms of agreement, privacy agreement and clear cache, etc.

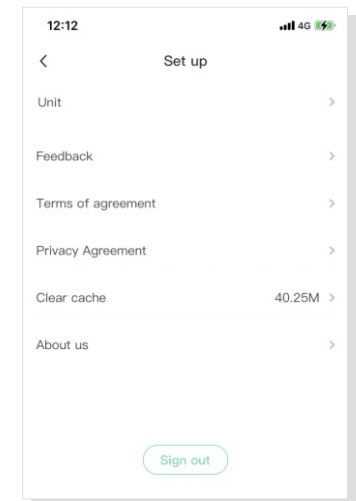

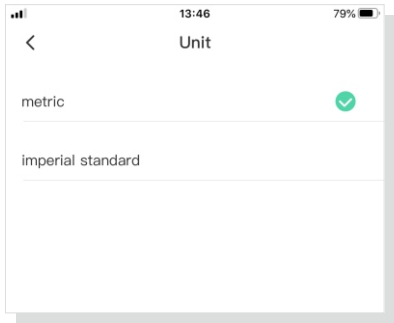

Unit settings (metric or imperial standard)

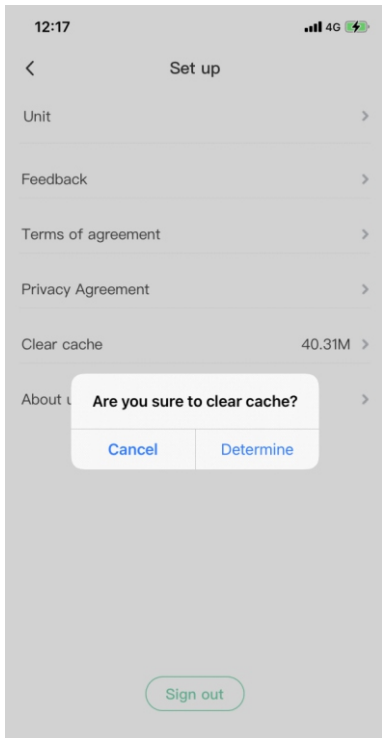

Clear Cache

Users can clean up the system cache according to users' needs, including Gymax App H5 web page load cache and image load cache.

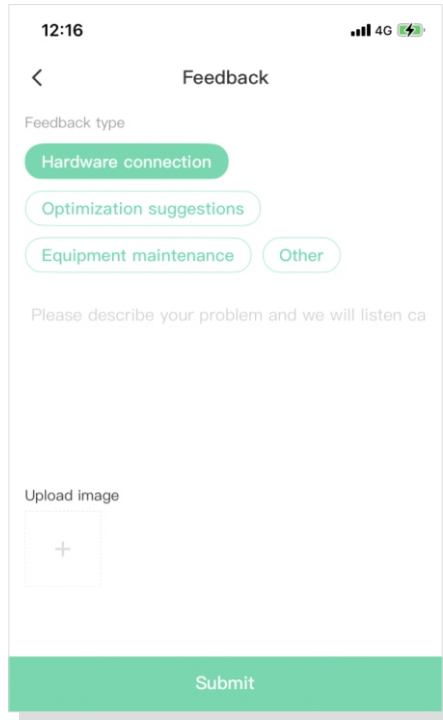

Feedback

Users can submit suggestions and the problem for improving the product.

**Welcome to visit our website and purchase our quality products!**

**With your inspiring rating, COSTWAY will be more consistent to offer you EASY SHOPPING EXPERIENCE, GOOD PRODUCTS and EFFICIENT SERVICE!**

**US office: Fontana, California**

**UK office: Ipswich**



- \* Reward Points
- \* Exclusive Customer Service
- \* Personalized Recommendations
- \* Permanent Shopping Cart
- \* Order History

*5 Star Rating*



**We would like to extend our heartfelt thanks to all of our customers for taking time to assemble this product and giving us valuable feedbacks.**

