

**CHASING**

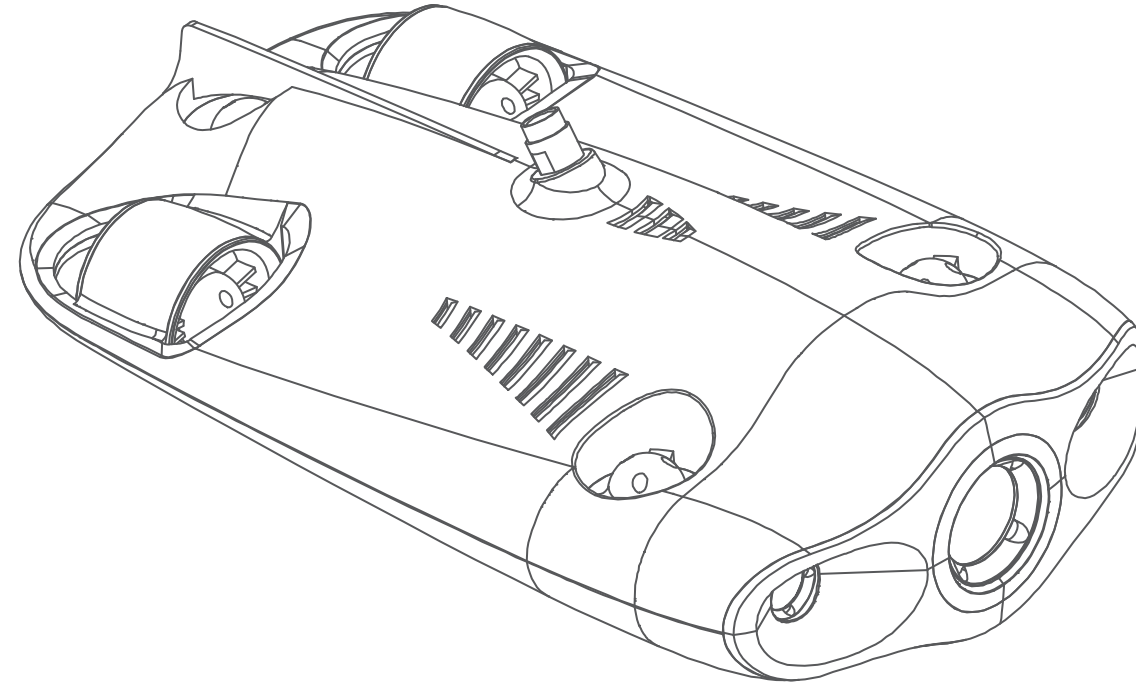

**GLADIUS mini**

Conquer the Waters

**CHASING**

[www.chasing.com](http://www.chasing.com)  
[support@chasing-innovation.com](mailto:support@chasing-innovation.com)

**User Manual**

Thank you for purchasing the Gladius Mini underwater drone. Please read this entire document carefully before using the drone. By using this product, you hereby signify that you have read this disclaimer and all instructions carefully and that you understand and agree to abide by the terms and conditions herein.

Gladius Mini is a small five thruster underwater drone used for real-time observation, exploration, photography, and video capture. Chasing accepts no liability for damage, injury, or any legal responsibility incurred directly or indirectly from the use of the Gladius Mini in the following conditions:

01. Damage(s) or injuries incurred when users are drunk, taking drugs, drug anesthesia, dizziness, fatigue, nausea and any other conditions no matter physically or mentally that could impair your ability.
02. Damage(s) or injuries caused by subjective intentional operations.
03. Any mental overcompensation caused by accident.
04. Failure to follow the guidance of the manual to assemble or operate.
05. Malfunctions caused by refit or replacement with non-Chasing accessories and parts, or unauthorized modification, disassembly, or shell opening not in accordance with official instructions.
06. Damage(s) or injuries caused by using third-party products or fake Chasing products.
07. Damage(s) or injuries caused by misoperation or subjective misjudgment.
08. Damage(s) or injuries caused by mechanical failures due to erosion, aging.
09. Damage(s) or injuries caused by operating the unit with a low battery alert.
10. Damage(s) or injuries caused by operating the drone out of maximum safe range and depth.
11. Damage(s) or injuries caused by knowingly operating the product in abnormal conditions (such as the assembly is not completed, or the main components have obvious faults, obvious defect or missing accessories).
12. Damage(s) or injuries caused by operating the drone in a sensitive zone such as a military area or private waters without official permission.
13. Damage or injury caused by using in bad water conditions (such as high winds, or turbid zone).
14. Damage or injury caused by uncontrollable external factors, including severe collision, tidal wave, swallowed by animal.
15. Damage(s) or injuries caused by infringement such as any data, photo or video material recorded by the use of the Gladius Mini.
16. Other losses that are not covered by the scope of Chasing's liability.

GLADIUS MINI Introduction .....	03-07
Drone .....	03
Base Station .....	04
Tether & Winder .....	05
Remote Controller .....	05
Phone/Tablet Mount .....	06
Phone/Tablet Mount Assembly .....	07
Installation & Connection .....	08-09
Video and Photo Download .....	10
Navigation .....	11
Charging Guide .....	12
Specifications .....	13
Maintenance and Precautions .....	14

## Drone

GLADIUS MINI is a small five thruster underwater drone used for real-time observation, exploration, photography, and video capture. Its body imitates that of a submarine, and its unique design lets the GLADIUS MINI move quickly with speeds up to 2m/s (3.89Knots). It has a depth-lock mode and a self stabilizing mode. The drone can move up and down vertically and can tilt +45°. It can dive up to 100 meters (330ft) and has a high-definition camera for shooting photos and videos. The drone is easy to operate and its small size allows it to be carried in a single backpack. It has a battery life of approximately 2 hours. Whether you're diving, fishing, taking underwater photography, or yachting, the GLADIUS MINI is your best choice.

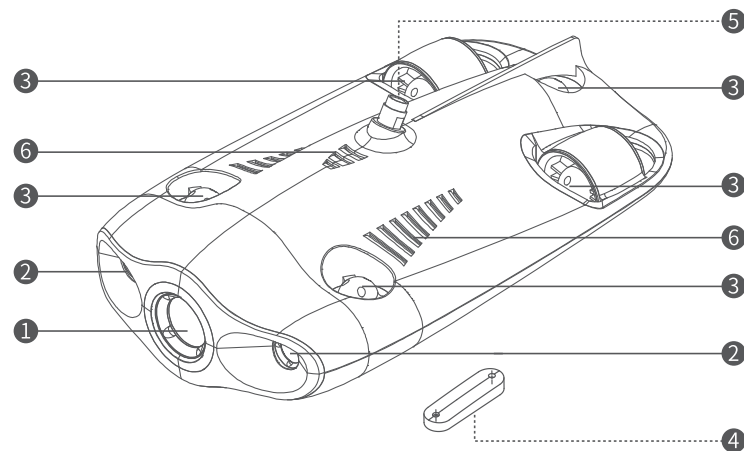

- ① 4K UHD Camera
- ② Dimmable LED Lights
- ③ Thrusters (5 Total)
- ④ Buoyancy Weight  
(Freshwater weight is installed on the drone by default. For saltwater dives, replace freshwater weight with included seawater weight)
- ⑤ Tether Connection Socket  
(Used for dives and charging)
- ⑥ Drain/Vent Holes

## Base Station

The base station is used to send and receive data to and from your drone. It connects directly to the drone via the included tether and connects wirelessly to your mobile phone/tablet via Wi-Fi. This allows the drone to display a live video feed on your phone/tablet and be controlled in real-time. The base station's HDMI output can also be used to display a live video feed to a larger television/monitor.

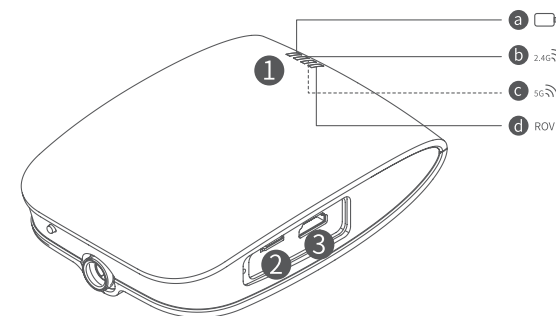

### Indicator Lights

- ① Indicator Lights
  - ② Micro SD Card Slot
  - ③ HDMI Socket
  - ④ Reset Button (Switch to 2.4G or 5G Wi-Fi)
  - ⑤ Tether Connection Socket (Used for dives and charging)
  - ⑥ Power Switch
- ▲ Note: To avoid damage, DO NOT put base station in water.

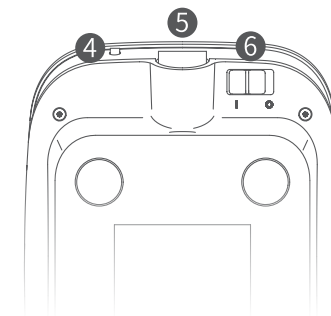

- ① Battery Icon: Base station battery indicator with three color states:  
( Red: less than 25% Yellow: 25~75% Green: 75~100% )
- ② 2.4G: 2.4G Wi-Fi indicator, always on when working.
- ③ 5G: 5G Wi-Fi indicator, always on when working.
- ④ ROV (Drone): Indicates the communication status between the base station and the drone. Steady light indicates successful connection. Blinking light indicates that the base station and drone are NOT connected.

## Tether & Winder

The tether is used to connect the drone and the base station. The winder is used to store the tether.

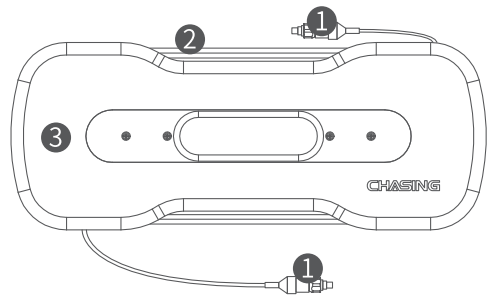

- ① Tether Connectors
- ② Tether
- ③ Winder

⚠ Warning: To avoid damage, do not put exposed (unconnected) tether connectors into water.

## Remote Controller

The remote controller is used to control the drone. It connects wirelessly via Bluetooth to your mobile phone/tablet. The remote controller's phone/tablet mount supports devices ranging from 5 inches to 10.5 inches.

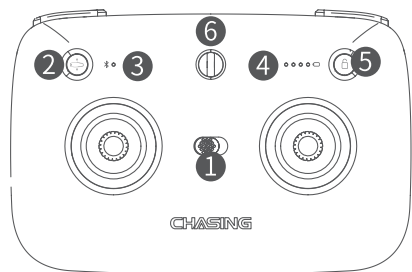

- ① **Power Switch:** Turns controller on/off.
- ② **Mode Switch:** Press to switch between depth-lock & self-stabilizing modes.
- ③ **Bluetooth Indicator:** Light is solid on when Bluetooth is connected. Light flashes when not connected or when charging.
- ④ **Power Indicator:** Each LED represents 25% of the controller's battery. When all four lights are on the battery is fully charged.
- ⑤ **Unlock/Lock:** Unlock/Lock the motors.
- ⑥ **Lanyard Attachment:** If desired, a safety lanyard can be attached here to prevent the controller from falling.

## Remote Controller

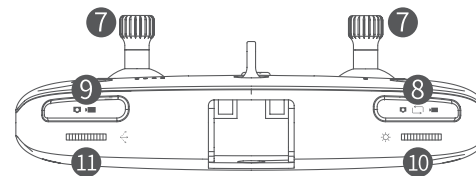

- ⑦ **Joysticks:** Used to control the navigation of the drone.
- ⑧ **Video/Photo Mode:** Press to switch between video and photo mode.
- ⑨ **Video/Photo :** Press to start/stop video recording or take photo.
- ⑩ **LED Light Control:** Scroll right/left to increase/decrease brightness of LED lights.
- ⑪ **Angle Adjustment:** Scroll right/left to raise/lower the head of the drone. Press dial down to return to horizontal position.

## Phone/Tablet Mount

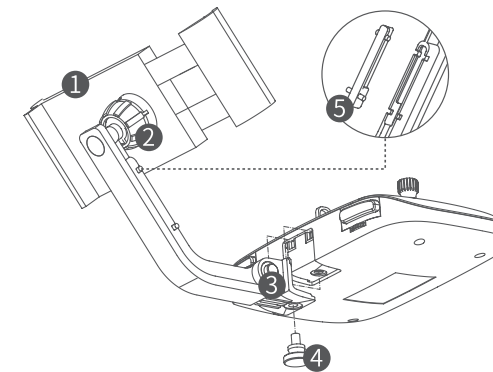

- ① **Phone/Tablet Mount:** Supports devices from 5 inches to 10.5 inches.
- ② **Adjustable Nut A:** Used to attach phone/tablet mount to mounting bracket.
- ③ **Adjustable Nut B:** Used to adjust mounting bracket angle.
- ④ **Adjustable Nut C:** Used to secure mounting bracket to controller.
- ⑤ **Built-in Tool:** Stored in bracket arm and used to tighten/ loosen Adjustable Nut B. Note: Tool can be removed from bracket arm by either set of points.

⚠ Note: Do not put the controller in the water to avoid damaging the device.



## Phone/Tablet Mount Assembly

1 Insert the mounting bracket into the mounting slot on the back of the controller.

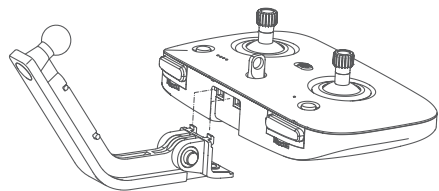

2 Insert and tighten mounting bracket screw (M5\*8).

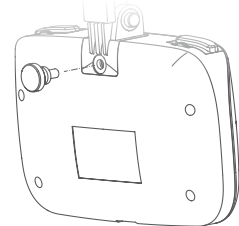

3 Remove the nut on the back of the phone/tablet mount.

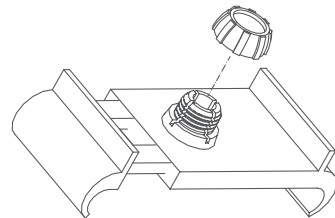

4 Place nut over mounting bracket swivel ball. Then snap mounting bracket onto phone/tablet mount and tighten nut.

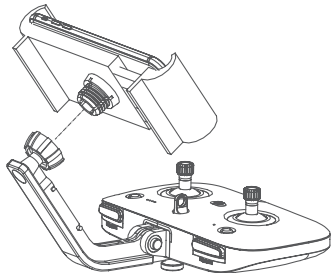

5 Insert phone/tablet and adjust to desired position.

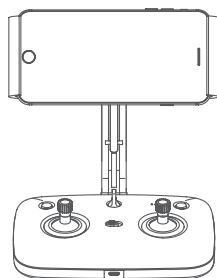

### 1 Download CHASING MINI App

CHASING MINI App: To download, scan the below QR code or visit the iOS App Store / Google Play. (For iOS 9.0/Android 4.4 and above)



### 2 Connect Drone with Base Station

Insert one end of the tether into the drone and the other end into the base station. Securely hand-tighten both nuts.

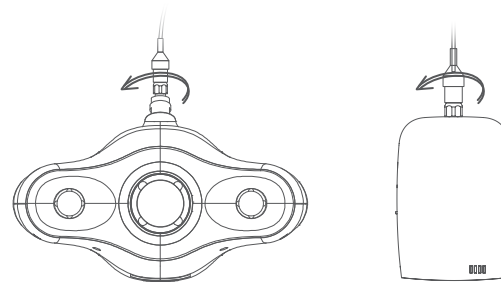

⚠ Warning: Extra O-rings are included in the parts bag.

### 3 Turn on Base Station

Locate the power switch on the back of the base station and turn it to the ON position (I is ON, O is OFF). After a few seconds, the base station power indicator lights up, 5G or 2.4G, and the drone LED lights will flash, accompanied by two self-test sounds.

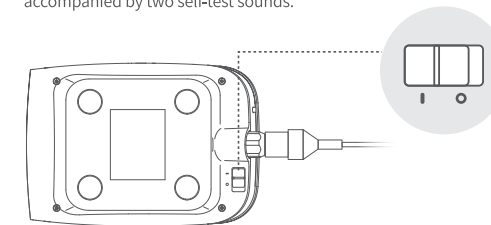

### 4 Wi-Fi Connection

On the Phone/Tablet, go to Wi-Fi settings. Wait for 5-10 seconds and the Gladius\_5G\_XXXX network will appear as an option. Click to connect and enter the Wi-Fi password: 12345678

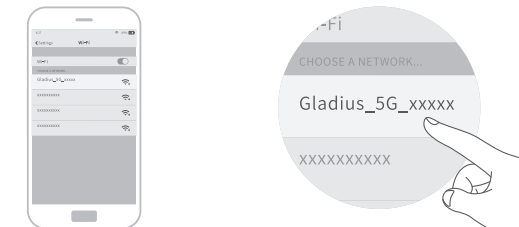

⚠ Warning: If desired, press the "reset" button of the base station to switch to Gladius\_2.4G\_XXXX Wi-Fi network.

## 5 Turn on Bluetooth

On phone/tablet, go to Bluetooth settings and make sure it is set to the ON position.

## 6 Turn on Controller

Turn the controller's power switch to the ON position. The Bluetooth indicator flashes and the battery indicator lights turn on.

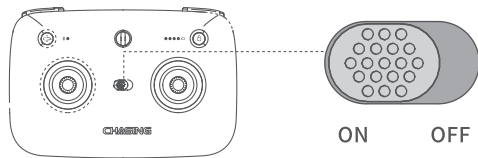

## 7 Connecting Controller and Mobile Phone

**[iOS]** Open the CHASING MINI App on the phone/tablet. A Bluetooth connection interface will pop up. Select the device name and click the 'select' button. Check the Bluetooth indicator on the controller for connection status. A solid ON light indicates a successful connection.

**[Android]** Open the CHASING MINI App on the phone/tablet. Click the 'start' button and the controller connection interface will pop up. Make sure all permissions are open. Then click the 'Connect Controller' button, select the device name, and click 'select.' Check the Bluetooth indicator on the controller for connection status. A solid ON light indicates a successful connection.

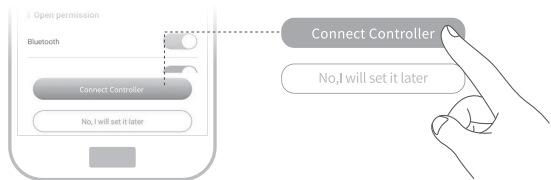

## 8 CHASING MINI App Usage

When you open the app for the first time, a tutorial is shown to get you started quickly. We recommend you watch patiently. After watching the tutorial, go to the app and you will see the live video feed of the Gladius Mini camera. Click the bottom propeller icon on the app to unlock the propeller controls. Once unlocked, movement of the controller's joysticks will drive rotation of the propellers.



Since the app will be updated frequently, the user manual will not explain the app in detail. For information about the app, controller, and Frequently Asked Questions, go to the app home screen, click the icon in the upper right corner and then select help. App details can also be found at [www.chasing.com/support](http://www.chasing.com/support).

## 9 Installing Buoyancy Weight

Use screw driver (not included) to change between the Seawater and the Freshwater buoyancy weight.

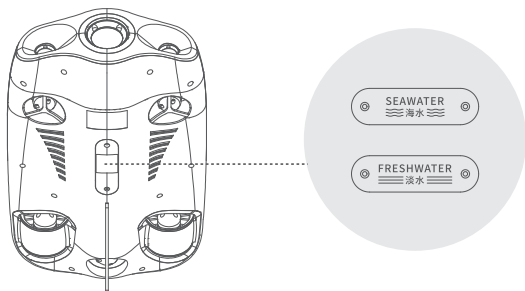

## 1 Connect Wi-Fi

- 1) Connect one end of the tether to the drone and the other end to the base station
- 2) Switch base station power to ON.
- 3) On phone/tablet, go to Wi-Fi settings and find Gladius\_5G\_xxxxxxx or Gladius\_2.4G\_xxxxxxx and select network.
- 4) Input the password: 12345678.

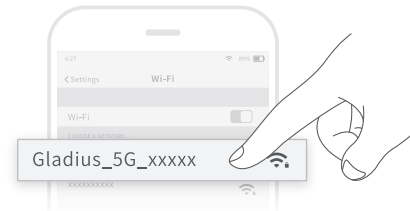

## 2a Download to Phone/Tablet

- 1) Open CHASING MINI App, click the Media button in the lower right corner.

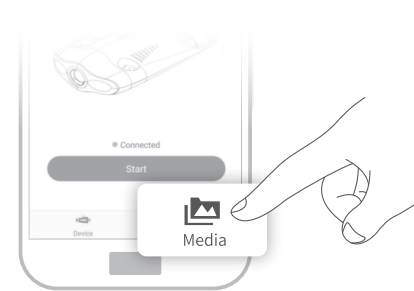

- 2) Find the video/photo that you want to download. Click the download button and the file will be saved directly to the phone/tablet's photo album (Download folder).

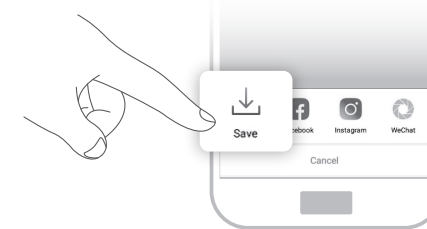





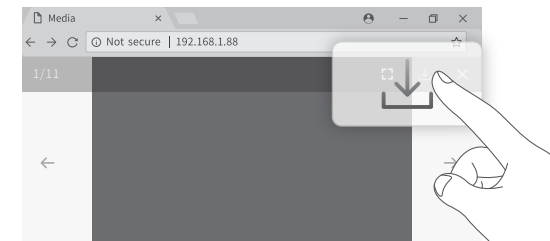



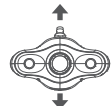

## 2b Download to Computer

- 1) On computer, go to Wi-Fi settings and find Gladius\_5G\_xxxxxxx or Gladius\_2.4\_Gxxxxxxx and select networks.
- 2) Open the web browser and type "gladius.mini" as the domain/web address.
- 3) Click the video or photo that you need to download. Click the download icon and save, which is generally saved in the Download folder.
- 4) To ensure the smooth download of photos and videos we recommend you use Firefox or Google Chrome.

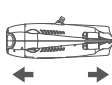

# Navigation

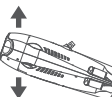
The Gladius Mini has 8 states: ascending, decending, left turn, right turn, forward, backward, lowering the head, and lifting the head. See details below on how to use the remote controller to navigate.

Drone (Flight Direction)	Remote Controller (American Hand)	Remote Controller (Japanese Hand)	Remote Controller Customization
Ascending/ Decending 	Left joystick up and down 	Right joystick up and down 	Supports customization
Turn Left/Right 	Left joystick left and right 	Left joystick left and right 	Supports customization
Forward/Backward 	Right joystick up and down 	Left joystick up and down 	Supports customization
Lowering the head/ Raising the head 	Scroll the right wheel to left for lowering the head, to right for lifting the head 	Scroll the right wheel to left for lowering the head, to right for lifting the head 	

▲ Note: The default remote controller mode in the CHASING MINI App is Japanese hand. You can switch to American hand or custom in the app.

# Charging Guide

**Drone:** Use the 3A Power Cord with 3A Power Adapter to charge the Drone.

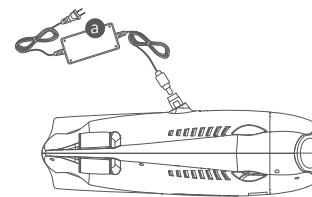

**a** Charging Status: When charging, the red light on the Power Adapter indicates normal charging in process while the green light indicates a complete charge.

**Base Station:** Use the 3A Power Cord with 3A Power Adapter to charge the Drone.

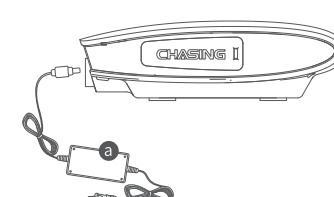

**a** Charging Status: When charging, the red light on the Power Adapter indicates normal charging in process while the green light indicates a complete charge.

**Remote Controller:** Use the Remote Controller Charging Cable (5v USB) to charge the Remote Controller. Charge for approximately 1 hour.

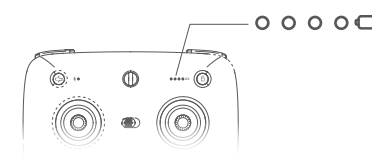

Turn Remote Controller ON to view charging status. When Charging, the Remote Controller's Bluetooth indicator light will continue to flash while the Power Status Indicator lights will turn on as charge increases. Each light represents 25% of the controllers battery. When all four lights are lit the battery is fully charged.

# Specifications

Base Station	
Weight	<0.88 lbs
Battery Capacity	29.25Wh (2500mAh)
Battery Life	≥6h (depending on the environment)
Battery Cycle	>300 times
HDMI Output	Yes
Size	5.9x4.2x1.8 inch
Wireless Wi-Fi Distance	≤32.8 ft
▲ Warning: The base station is not waterproof and should not be put into water.	

Dimmable LED Lights	
Brightness	2x1200LM
Color Temperature	4000K-5000K
CRI	80
Maximum Power	2x10W
Dimming	Manually adjustable

Tether & Winder	
Weight	2.65lbs(164 ft)/3.97lbs(328 ft)
Tether	50m/100m

# Specifications

Drone	
Size	15.2x8.9x5.4 inch
Battery Capacity	55.5Wh (5000mAh)
Weight	<5.5 lbs
Buoyancy	-0.02 lbs~.02 lbs
Operating Temperature	14°F~140°F
Maximum Depth	328 ft
Maximum Speed	4Kn (2m/s)
Maximum Rise/Fall Speed	2Kn (1m/s)
Maximum Flow Resistance	2Kn (1m/s)
Battery Life	2h(Forward at low speed in fixed depth mode)
Battery Cycle	>300 times

Remote Controller	
Working Frequency	2.4GHz-2.485GHz
Wireless Distance (Between smart device and controller)	<32.8 ft
Charging Time	1h
Battery Life	5h
<p>▲ Note: To view battery status indicator while charging, remote controller must be turned ON.</p>	

Sensor	
IMU	Three-axis gyroscope/acceleration/compass
Depth Sensor	+/- 1.64 ft
Temperature Sensor	+/- 35.6°F

Camera	
CMOS	1/2.3 inch
Aperture	F3.0
Focal Length	4.0mm
ISO Range	100-3200 (Still camera only)
Field of View	95°
Maximum Image Resolution	12M(4000*3000)
Image File Types	JPEG/DNG
Video Resolution	FHD: 1920x1080 30Fps
	FHD: 1920x1080 60Fps
	FHD: 1920x1080 120Fps
	UHD: 3840x2160(4K) 30fps
Video Maximum Stream	60M
Video Type	MP4
SD Card Memory	64G

Adapter	
Adapter	3A/12.6V
Drone Charging Time	2h
Base Station Charging Time	1h
<p>▲ Note: Maximum Image Resolution</p>	

# Maintenance and Precautions

## 1 Navigation Safety



Open sea navigation



Relatively clear water quality, no dense seaweed



No dense radio or radar signals

330ft  
↓

Do not dive more than 330 ft.

## 2 Battery Protection



Do not run out of battery power



Charge when power is less than 25%



When not in use, keep battery power at 50% - 70%



Working temperature  
-10°C ~ 60°C  
(-18°F-108°F)

## 3 Charging Protection

- Only use the official standard adapter.
- Red light means charging.
- Green light means the the charge is complete.
- Unplug the adapter when charging is complete.

## 4 Thruster/ Propeller

- After use, clean the attachments on the thrusters (make sure the drone is completely off). Rinse with fresh water and dry with a dust-free cloth.

## 5 Tether

- Before use, check for water on the tether connectors. If present, wipe with provided absorbent towel.

## Other

1. Do not turn on the drones LED lights before entering the water .
2. Rusted screws should be replaced immediately.
3. After each use, rinse the drone with fresh water and dry with absorbent towel.
4. The base station should be wiped with a cloth. Do not rinse with water.
5. Do not place heavy objects on drone or accessories to avoid possible damage.
6. People under the age of 16 should only use this drone under adult super vision.
7. When not in use, do not expose drone and accessories to sunlight. Store it in a cool place or in a special box.
8. Chloride or other chemicals can erode GLADIUS MINI. Do not use if pool contains high chlorine levels.
9. Do not run drone motors out of water for more than two minutes to avoid wearing out thrusters.

## Support

1. If you have any questions, please send an email to support@chasing-innovation.com or contact E-chat customer service.
2. You can search on Facebook: Gladius Mini Group, join the official Gladius group to get more official news and app update notifications, or share your wonderful photos with other customers.